

EC 250-F 4T

USER MANUAL

2012



GASGAS



FOREWORD

GAS GAS thanks you for your confidence.

By choosing the new GAS GAS EC 250-F 2012 you have just entered the great GAS GAS family and, as a user of the number one off-road motorbike manufacturer, you deserve the distinguished treatment that we wish to offer to you both in our after-sale relationship and in the explanations that we provide in this manual.

Our EC 250-F is a bike conceived for highly competitive performance. In fact this bike is the fruit of many years of competition and experimentation in these demanding disciplines; many great trial riders have contributed their expertise and achievements to the essential data we have used to create these high-quality, exclusive motorcycles incorporating key features such as reliability, high performance and stability.

Congratulations for making, without a doubt, the right choice. With skill at the controls of this motorbike, an adequate preparation and the corresponding essential servicing this GAS GAS will remain highly reliable and you will be able to enjoy the most comfortable and rewarding motor sport.

Thank you for your confidence and welcome to GAS GAS motos SA.

December 2011

IMPORTANT NOTICE

Read this manual carefully. This manual covers aspects that will contribute to your security and to that of others, as well as guaranteeing a correct conservation and maintenance of this GAS GAS motorcycle you have just acquired.

All of the instructions to correctly handle and drive this motorcycle are described in detail. Each message will be preceded by a symbol.

WARNING

This title identifies special instructions or procedures that, if not correctly followed, could result in personal injury, or even death.

CAUTION

This title identifies special instructions or procedures that, if not strictly observed, could result in damage to or destruction of equipment.

NOTE

This title indicates points of particular interest for more efficient and convenient operation.

Inadequate driving skill could cause problems to the environment and conflict with other people. Responsible use of your motorcycle will ensure that these problems and conflicts do not occur.

TO PROTECT THE FUTURE OF YOUR SPORT, MAKE SURE YOU USE YOUR BIKE LEGALLY, WITH CONCERN FOR THE ENVIRONMENT, AND RESPECT THE RIGHTS OF OTHER PEOPLE.

Motorcycle riding is a fantastic sport, and we hope you will enjoy it to the fullest.

GASGAS

OIL RECOMMENDED:



TABLE OF CONTENTS

Foreword.....	3	Chain guide.....	26
Important notice.....	4	Tension adjustment.....	27
Table of contents.....	5	Handle bars.....	29
Specifications.....	6	Brakes.....	29
Component locations.....	8	Steering.....	31
Side stand.....	10	Steering lock.....	32
Petrol.....	10	Front forks.....	33
Serial number and the qualification approval plate.....	11	Rear suspension.....	36
Starting and stopping the engine.....	12	Wheels.....	38
Cold starting.....	13	Cleaning.....	39
Gear changes.....	13	Tighten bolts and nuts.....	40
Stopping the motorcycle.....	14	Tightening torque table.....	41
Break-in.....	14	Lubrication.....	42
Maintenance chart.....	15	Engine oil.....	43
Battery.....	16	Suspension adjustment.....	46
Cooling system.....	17	In competition.....	50
Spark plug.....	20	Storage.....	51
Air filter.....	23	Multi-function instructions.....	52
Accelerator cable.....	24	Fault diagnosis.....	58
Clutch.....	25	Electrical schemas.....	64
Exhaust system.....	25	Guarantee manual.....	66

SPECIFICATIONS

ENGINE

Engine	4 stroke, single-cylinder DOHC 5 valves, liquid cooled
Displacement in cubic centimetres	249cc
Bore and stroke	77 x 53,6mm
Fuel supply	Carburator Keihin FCR MX37

TRANSMISSION

Transmission type	5 speed
Clutch type	Multi disc wet clutch with hydraulic command
Secondary transmission	Chain
Gear ratio	1st 2.385 (31/13) 2nd 1.750 (28/16) 3rd 1.353 (23/17) 4th 1.095 (23/21) 5th 0.895 (17/19)
Primary reduction ratio	3.353 (57/17)
Final reduction ratio	3.846 (50/13)
Overall drive ratio	11 .5 (5th)
Transmission oil	Capacity Type
	1.300 cc SAE 5W40 API SG

CHASSIS

Type	DELATABOX, semi double cradle chassis made from "B" profile Cromoly tubes.	
Tyre sizes	Front	Aluminium rocker
		EC - 90/90 x 21
	Rear	EC SM - 120/60 ZR17
		EC - 140/80 x 18 EC SM - 150/60 ZR17

Suspension	Front	ø 48 mm inverted fork with closed cartridge and shock preload regulation Progressive system with single multi-adjustment shock absorber
	Rear	
Suspension stroke	Front	305 mm
	Rear	298 mm
Front suspension oil		Between SAE 5 and 7.5 (check manufacturer's information)
Front fork oil level		320cc

<i>BRAKES</i>		
Type	Front / rear	Disk brakes, pump and double callipers / simple
Effective disk diameter	Front	260 mm
	Rear	220 mm

<i>DIMENSIONS</i>	
Overall height	1260 mm
Overall length	2135 mm
Overall width	810 mm
Wheel base	1475 mm
Minimum ground clearance	340 mm
Fuel tank capacity	7 litres
Weight	118 Kg

(Specifications subject to change without notification, also possibly not applicable in some countries).

LOCATION OF COMPONENTS

GAS GAS EC250 F

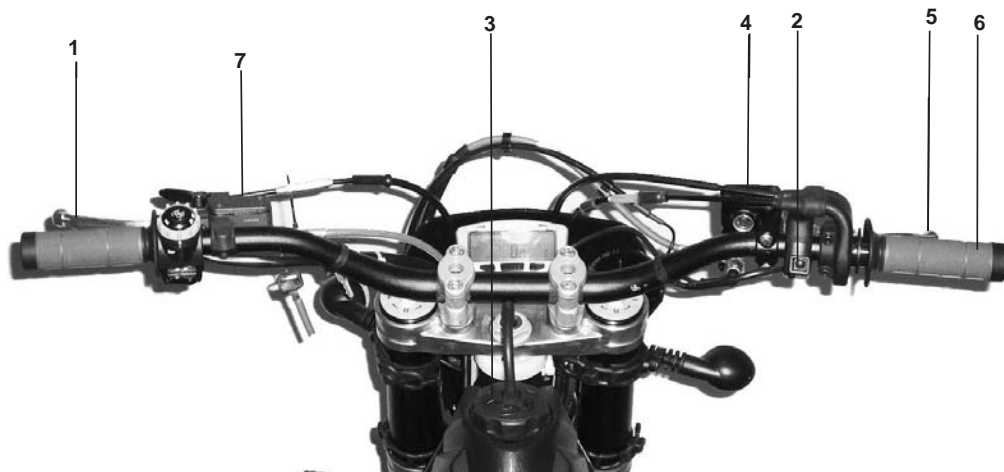

- 1- Clutch handle
- 2- Engine start button
- 3- Fuel tank cap
- 4- Front brake fluid tank
- 5- Front brake handle
- 6- Throttle control
- 7- Clutch fluid tank

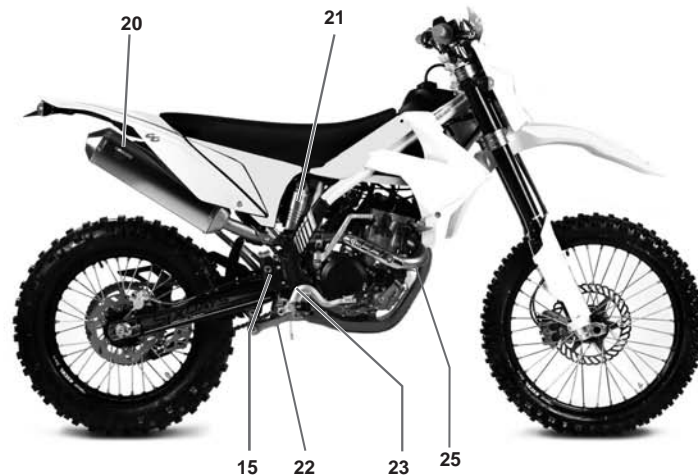
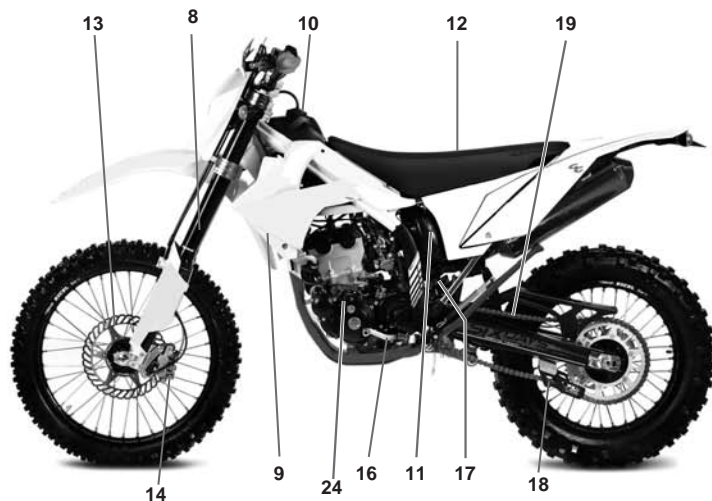

- 8- Front suspension
- 9- Radiator
- 10- Fuel tank
- 11- Air filter
- 12- Seat
- 13- Front brake disk
- 14- Front brake callipers
- 15- Rear brake fluid tank
- 16- Shift pedal

- 17- Rear shock absorber
- 18- Chain guide
- 18- Chain
- 20- Silencer
- 21- Rear shock absorber gas tank
- 22- Tie rod and rocker suspension
- 23- Rear brake pedal
- 24- Engine oil cap
- 25- Exhaust bend

SIDE STAND

To unfold the side stand **(A)** must be opened to vertical position.

The stand returns to its original position with the aid of the spring **(B)**.

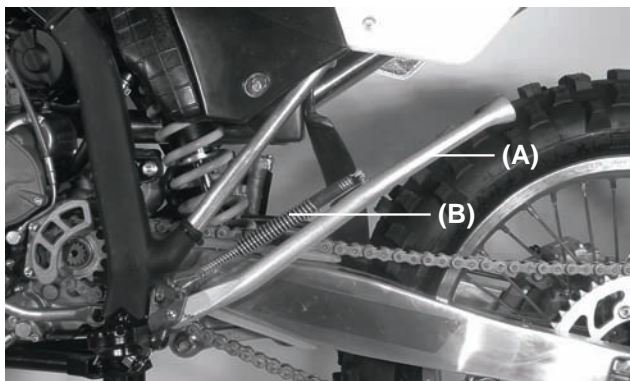

(A). Side stand.
(B). Spring.

NOTE

Do not start the engine or ride the motorcycle when the side stand is down.

PETROL

The GAS GAS EC 250 F has a four stroke engine and requires 98 octane, unleaded petrol.

Fuel Tank Capacity
7 L

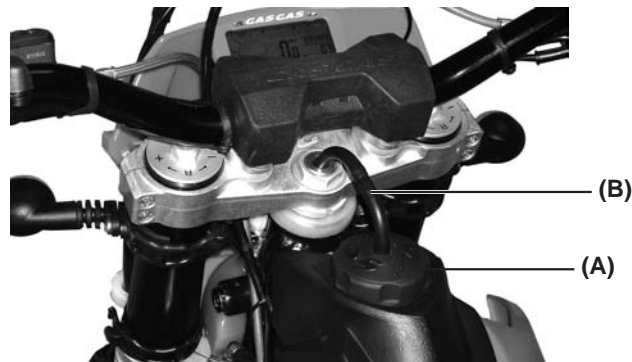

(A). Fuel cap.
(B). Fuel vent hose.

To open the gas tank cover **(A)**, turn it anti-clockwise.

To close the fuel cap, rotate it in a clockwise direction.

RECOMMENDED FUEL

Use lead-free petrol with an octane rating equal to or higher than that shown in the table.

OCTANE RATING METHOD	OCTANE RATING (MIN)
Antiknock Index (RON+MON)/2	90
Research Octane No. (RON)	98

NOTE

If knocking occurs, try a different brand of gasoline or higher octane grade.

WARNING

Gasoline is extremely flammable and can be explosive under certain conditions. Always stop the engine and do not smoke. Make sure the area is well ventilated and free from any source of flame or sparks; this includes any appliance with a pilot light.

SERIAL NUMBER

Printed on the steering tube. Indicates the frame number with which the motorcycle is registered.

Qualification approval plate

The motorcycle is fitted with its own corresponding qualification approval plate with the serial number, also printed on the steering tube and whose data also coincides with that in the documents.

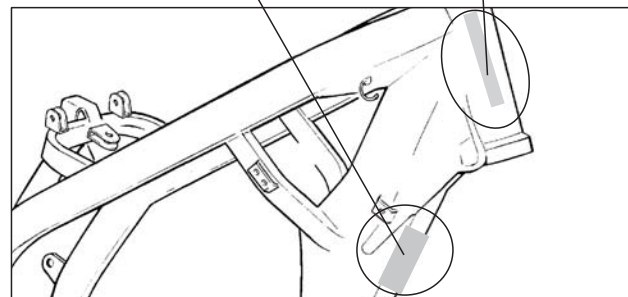

STARTING THE ENGINE

- Ensure that the motorcycle is in neutral.
- Press button **(A)** to turn on the electrical circuit, so that the motor may be started.

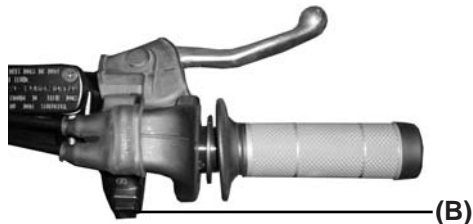
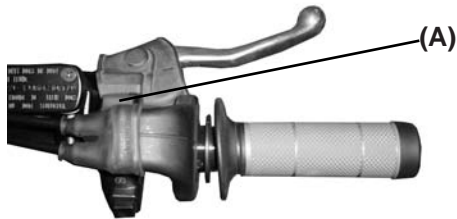

- Without using the throttle, press the electric start button **(B)**.

STOPPING THE ENGINE

- Change gear to neutral.
- After accelerating lightly, cut the gas completely and press button **(C)**. The electrical circuits are closed.

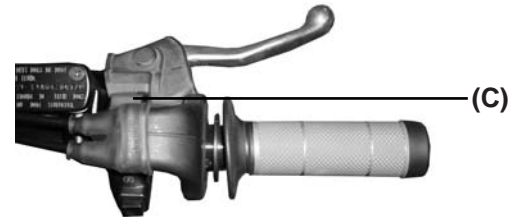

NOTE

Start the engine soon after making contact with the ON button (A) or the battery may lose its charge.

COLD STARTING

To do the cold start, pull the starter.



- There is no need to use the throttle, simply start the engine. Note that the engine will start after a certain number of revolutions.

After the warming time, you can pull out the cold starter. With the cold start, the bike warm slowly without damages.

NOTE

- If the engine is drowned, you can press the hot starter and on the same time, press the kick pedal 10 at 20 times. When the engine is dry, you can start normally.

HOT START

Don't use the cold start and don't touch the trottle. Press the hot starter and start the engine with the kick or the electric starter. When the engine is running, pull out the hot start.

SHIFTING GEARS

The transmission is with 5 speeds, return shift type meaning that to go back to first gear from a higher gear, you must shift back through the gears one by one.

To engage first gear from neutral, pull in the clutch lever and push down on the shift pedal then release the pressure on the shift pedal and gently release the clutch lever.

CAUTION

When changing gears, press firmly on the shift pedal to ensure complete, positive shifting. Careless, incomplete shifts can cause the transmission to jump out of gear and lead to engine damage.

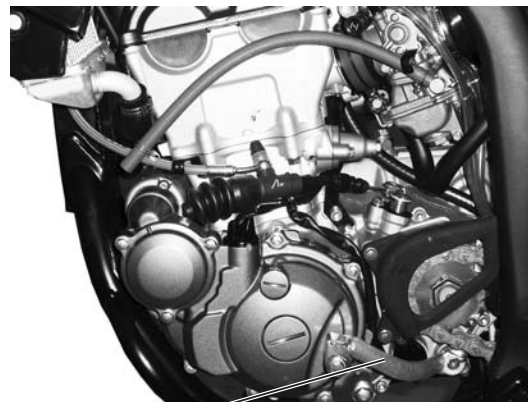

(B)

(B). Shift pedal.

STOPPING THE MOTORCYCLE

For maximum deceleration, close the throttle (A) and apply both front and rear brakes. Disengage the clutch as the motorcycle comes to a stop. Independent use of the front or rear brake may be advantageous under certain conditions.

Downshift progressively as speed is reduced to ensure good engine response when you want to accelerate.



BREAK-IN

To obtain the proper operating clearances in the engine and transmission that are necessary for smooth engine performance and reliability, an initial break-in must be completed. For the first hour or 100 Km of operation, run the engine at low rpm.

NOTE

The slow speed necessary during the break-in period may cause carbon to build up on the spark plug and soil it. If inspection of the spark plug shows this to be the case, replace the standard spark plug with a higher heat grade spark plug for the duration of the break-in period.

Break-in following these steps:

1. Start the engine and let it run at idle until the engine is thoroughly warmed up.
2. Stop and let the engine cool completely
3. Start the engine and ride for 10 minutes at moderate speed. **NEVER ACCELERATE FULLY.**
4. Stop and let the engine cool completely. Check and adjust chain slack and spoke tightness and make a general inspection.
5. Start the engine and ride for 20 minutes at moderate engine speed. **NEVER ACCELERATE FULLY.**
6. Stop and let the engine cool completely. Check and adjust (4).
7. Fit the inspected parts.
8. Fill the radiator up completely with cooling liquid. Before starting the engine bleed the air from the cooling system.
9. Start the engine and ride for 30 minutes at moderate speed.
10. Stop and let the engine cool completely. Check and adjust (4).
11. After the break-in procedure has been properly carried out, the motorcycle is ready for regular operation.

CAUTION

In any case, even an imprudent acceleration can cause engine trouble, take special care and use the proper skills and techniques required for correct driving of the motorcycle.

NOTE

Following the break-in, fit a new standard spark plug.

MAINTENANCE CHART			
Article	Period First 5 hours	Period Every 30 hours	Period Every 60 hours
Air filter	Inspect each time that the motorcycle has run or when necessary		
*Exhaust connectors and bolts	T	T	T
*Valve tolerances	I	-	I
Spark plug	-	I	R
Fuel tub	I	I	I
		*Revise every 4 years	
Engine oil and filter oil	R	R	R
*Engine oil pipes	I	I	I
Coolant	-	I	I
		Revise every 2 years	
Radiator hoses	I	I	I
Clutch	I	I	I
Chain	Clean, lubricate and inspect each time the motorcycle has run		
*Brakes	I	I	I
Brake lines	I	I	I
		*Revise every 4 years	
Brake liquid	I	I	I
		*Revise every 2 years	
Tyres	Inspect tyres for damage and check the tyre pressure every time the motorcycle has run		
*Steering assembly	I	-	I
*Front forks	I	-	I
*Rear suspension	I	-	I
*Chassis bolts and nuts	T	T	T

NOTE: I = Inspect and clean, adjust, replace or lubricate if necessary; R = Replace, T = Tighten, C = Clean

BATTERY

This battery is maintenance free and checking the fluid level is not required. It is advisable to check the charge of the battery periodically

To remove the battery, follow these steps:

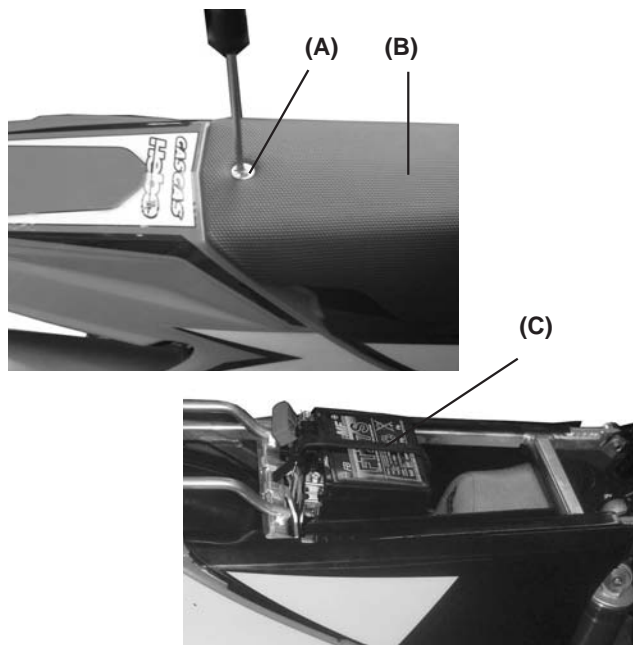

1. Remove the bolt (A) and remove the seat (B).
2. Release the rubber (C).

3. Disconnect the terminals ensuring that they do not enter into contact with metal parts then extract the battery.

WARNING

Hydrogen gas produced by the battery may explode if exposed to open flame or sparks.
Keep the area ventilated and free from naked flames.

The operating instructions for the battery are as follows:

1. Check the battery tension in open circuit status (disconnected).
2. In case the battery's tension is below 12.60 V, or if the storage period has exceeded 6 months, the battery has to be recharged following the instructions in paragraph 3.

If the battery voltage is above 12.60 V, the battery can be installed on the vehicle without having to recharge it.

- 3.1. Constant voltage charge mode.
 - Constant voltage = 14.40 - 14.70V
 - Initial charge current = 0.1 – 0.5 Cn
 - Charge duration = 6 hours minimum / 24 hours maximum.
- 3.2. Constant power charge mode.
 - Maximum charge current = 0.1 Cn

- Recommended charging duration = 5 - 8 hours.
- The product (charge current) X (charge duration) must be within the range: 0.5 - 0.8 Cn.

Note

In case that a different mode of charging is used to those established here, never exceed the maximum allowed currents nor the maximum charge duration of 24 hours.

CAUTION

Not using the standard manner of charging may seriously shorten the battery life.
Never exceed the standard charge.

CAUTION

Inverting the polarity of the battery terminals may cause battery charge problems and cause damage to the battery system.
The red terminal is positive (+) and the black terminal is negative (-).

THE COOLING SYSTEM**Radiator hose**

Check the radiator hoses for cracks or deterioration, and connections for leaks.

Radiator

Check the radiator fins for obstruction by insects or mud. Clean off any obstructions with a stream of low-pressure water.

CAUTION

Using a high pressure water source could damage the radiator fins and render it ineffective.
Do not obstruct or deviate the radiator air intake by installing non-approved accessories. Interfering with the radiator could cause overheating and result in engine damage.

Coolant

This absorbs excessive heat from the engine and transfers it to the air at the radiator. If the coolant level becomes low, the engine overheats and may suffer severe damage. Check the coolant level each day before riding the motorcycle. Replenish coolant if the level is low.

WARNING

To avoid burns, do not remove the radiator cap or try to change the coolant when the engine is still hot. Wait for it to cool down.

Anti-freeze liquid information

To protect the cooling system aluminium parts (engine and radiator) from rust and corrosion, the use of corrosion and rust inhibitor chemicals in the coolant is essential. If coolant containing corrosion and rust inhibitor chemicals is not used, over a period of time, the radiator will rust. This will block the cooling hoses.

CAUTION

Use of incorrect coolant solutions will cause severe engine and cooling system damage.

Use coolant containing corrosion inhibitors made specifically for aluminium engines and radiators in accordance with the instructions of the manufacturer.

WARNING

Coolant chemicals are harmful to the human body. Follow coolant manufacturer warnings and coolant handling instructions.

CAUTION

Soft or distilled water must be used with the inhibitor chemicals and the antifreeze in the cooling system.

If normal water is used in the system, the cooling system tubes may become blocked.

If the lowest ambient temperature encountered falls below the freezing point of water, protect the cooling system against freezing. Use a permanent type of anti-freeze (soft water and ethylene glycol plus corrosion and rust inhibitor chemicals for aluminium engines and radiators) in the cooling system.

For the coolant mixture ratio under extreme conditions, choose the mixture ratio listed on the container for the lowest ambient temperature.

Coolant Level

- Situate the motorcycle so that it is perpendicular to the ground.
- Remove the radiator cap in two stages. First turn the cap anti-clock wise and wait for a few seconds. Then push and turn it further in the same direction to remove the cap.

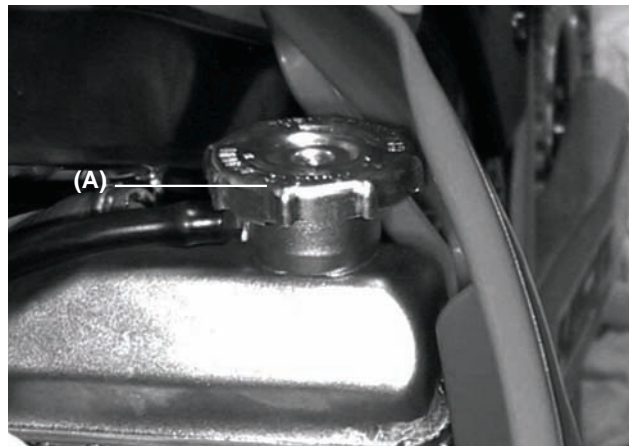

(A). Radiator Cap.

CAUTION

Permanent types of antifreeze on the market have anticorrosion and anti-rust properties. When diluted excessively these lose their antifreeze and anticorrosion properties. These must be diluted in accordance with the instructions of manufacturer.

NOTE

Check the level when the engine is cold.

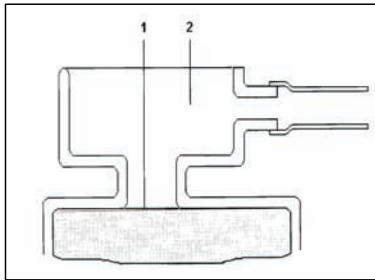

(1). Coolant level.
(2). Filler opening.

If the coolant level is low, add the correct amount of coolant through the filler opening.

Recommended liquid

Permanent type of antifreeze (distilled water and ethylene glycol) with corrosion and rust inhibitor chemicals for aluminium engines and radiators).

NOTE

Initially a permanent type of antifreeze is installed in the cooling system by the manufacturer. This is green in colour, containing 30 % ethylene glycol with a freezing point of -18°C .

Changing the coolant

- The coolant should be changed periodically to ensure long engine life.
- Wait for the engine to cool completely.
- Situate the motorcycle so that it is perpendicular to the ground.
- Remove the radiator cap.
- Place a bowl under the water pump cover and remove all the liquid in the radiator and engine, unlock the drain screw (B). Immediately wipe or wash off any coolant that spills on the frame, engine, or wheels.

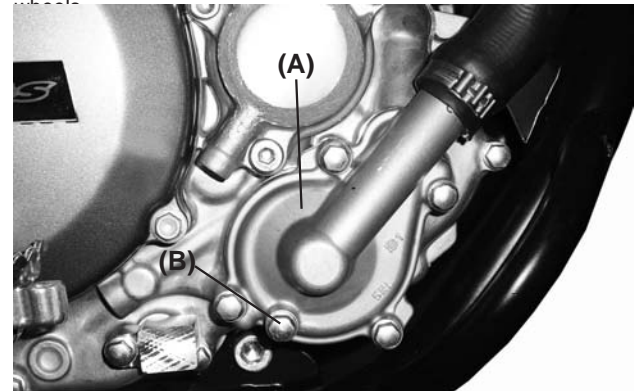

(A). Water pump cover.
(B). Screw to drain.

WARNING

If coolant gets on the tyres this will make them slippery and could result in an accident.

- Examine the used coolant. If white cotton-like patches appear in the liquid then this means that the aluminium elements of the cooling system are corroded. If the liquid is brown then this means that the steel or iron parts of the system are oxidized. In either case clean out the system.
- Check the cooling system for damage, loose joints, or leaks.
- Put the drain screw on the water pump cover and lock it with the indicated torque. Change the copper washer by a new one.

Screw torque:
Drain screw on the water pump cover: 9 Nm.

- Fill the radiator up to the edge and install the radiator cap.
- Check the cooling system for leaks.
- Start the engine, warm up the engine, and then stop it.
- Check the coolant level after the engine cools down. Add coolant up to the bottom of the radiator filler neck.

SPARK PLUG

The standard spark plug is indicated inside the table and the torque to lock it is 13 Nm.

Standard spark plug

Standard spark plug Gap between electrodes: 0.7-0.8 mm.

The spark plug should be taken out periodically to check the electrode gap. If the plug is oily or has carbon build up on it the clean it with a sand blaster. Following abrasive particle cleaning, the spark plug should be cleaned with a wire brush or similar. Measure the distance

between electrodes using a gauge and adjust in case that it is not correct by bending the outer electrode. If the spark plug electrodes are oxidised, damaged or the insulation is broken then replace the plug.

NOTE

Inspect every 30 hours. Replace every 60 hours.

To find the correct heat grade spark plug is being used, take it out and examine the insulation around the electrode. If the ceramic is light brown, the spark plug is correctly matched to engine temperature. If the ceramic is white, the plug should be replaced with the next coldest plug. If the ceramic is black, the plug should be replaced with the next hottest plug.

NOTE

If the engine output decreases, replace the spark plug to regain performance.

Spark plug maintenance

COMMENTS
If the standard spark plug is wet then replace it.
If the standard spark plug looks glassy or has a white colour, replace it

WARNING

An incorrectly fitted spark plug, or an incorrect temperature can lead to severe damage to the engine, and this damage is not covered by the warranty.

Always use the manufacturer's recommended brand of spark plug. Check with your dealer or a qualified mechanic to determine the correct spark plug for your motorbike.

Removing the spark plug

To remove the spark plug, follow these steps:

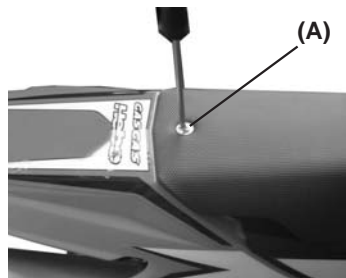

1. Remove the bolt (A) and remove the seat (B).

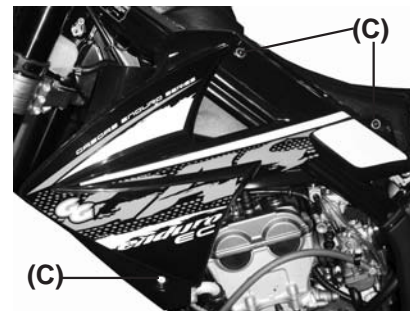

2. Remove the bolts (C) (left and right).

3. Remove the rubber attachment on the tank (D).

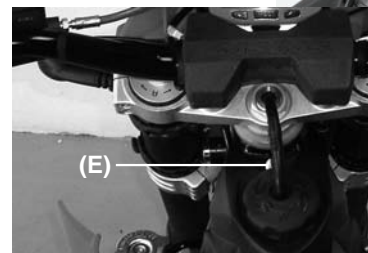
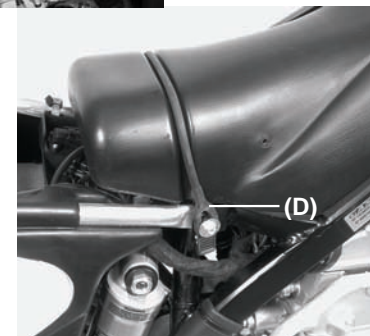

4. Remove the tank securing bolt (E).

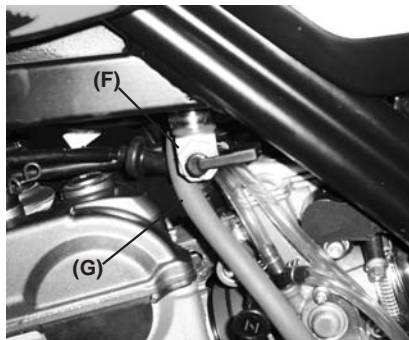

5. Close the fuel tap F and remove the fuel tub G.

WARNING

Becareful to the fuel loss when you remove the fuel tub, the fuel is highly flammable.

Stop the engine, before to remove the fuel tank. Take care to be inside a well-ventilated area that there is no sparks or flame anywhere near the working zone.



6. Remove the spark plug hood.

NOTE

A cap protects the spark plug. Keep this clean and dry.

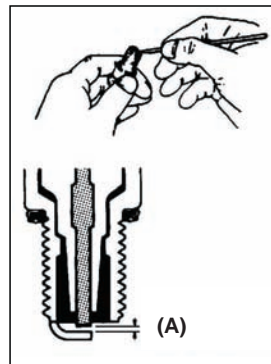

7. Take out the spark plug and clean carbon deposits from the spark plug with a small tip or a metallic brush. Readjust the gap (A) in the plug between 0.7 and 0.8 mm. (0.028 – 0.031 in). Before removing the carbon deposits, check its colour; this colour tells us whether the standard plug is the best for our use.

AIR FILTER

An obstructed air filter restricts the air intake of the engine, increasing the petrol consumption and reducing the engine power as well as the destruction of the spark plug.

WARNING

An obstructed air filter may allow dirt to enter into the injector blocking it open; this could lead to an accident.

CAUTION

An obstructed air filter will allow dirt to enter the engine causing excess wear and engine damage.

Inspect this without fault, before and after each race or session. Clean if necessary.

Cleaning the air filter

WARNING

Clean the filter in a well-ventilated zone and ensure that there are no sources of naked flame or sparks near the work area (including the focus of a powerful light). Do not use petrol to clean the filter as this could result in an explosion.

- Remove the seat.
- Remove the bracket (A) and remove the filter (B).

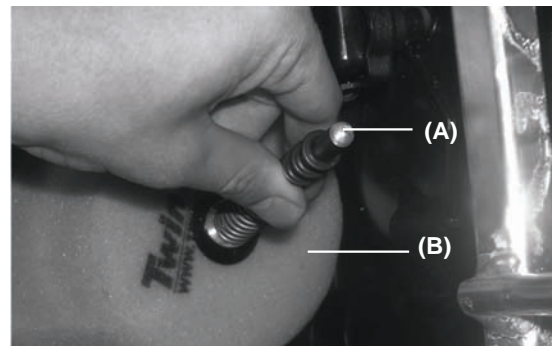

Stuff a clean, lint-free towel into the intake manifold so that no dirt is allowed to enter.

CAUTION

Do not spin the filter on its cage. It is possible to tear or damage the filter.

- Clean inside the filter housing using a damp cloth.

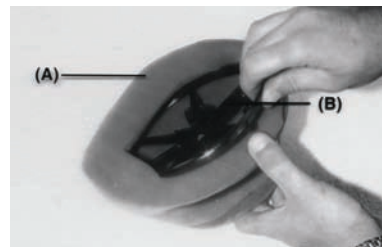

Remove the cage (B) from the air filter (A).

- Clean the filter in a filter bath using a soft brush.



- Squeeze it and take it out with a clean cloth.

- Check the air filter for damage such as scraping, hardening, shrinkage. If it is damaged then replace otherwise dirt will enter the throttle body.
- Grease all of the connections and bolts of the air filter and inlets.

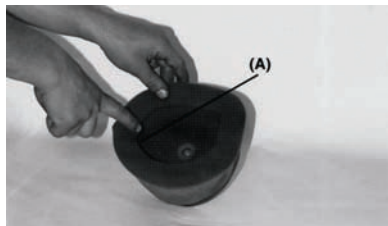

- Install the filter in the cage and cover the filter lip (A) with a thick layer of grease to ensure a seal and to avoid dust penetration.

- Fit the air filter to the motorcycle and ensure that it is correctly connected.

THROTTLE CABLE

- Check that the throttle grip turns smoothly
- Check that the throttle grip has 2-3 mm of play.
- If the clearance is incorrect, pull out the rubber protection from the tensioner (A), unlock the locknut (B) and adjust the tolerance with the tensioner. Lock after the locknut and push the rubber protection on it.

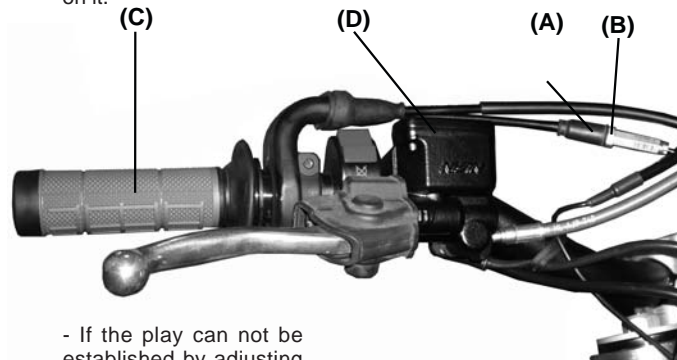

- If the play can not be established by adjusting the cable, remove the cable protection from the throttle, adjust this using a tensioning device at the end of the cable, tighten the lock nut and refit the protection.

- (A). Adjustment.
- (B). Lock nut.
- (C). Throttle grip.
- (D). Brake fluid reservoir.

NOTES:

Before the cable adjustment, you must adjust the idle.

WARNING:

After the adjustment, start the engine and turn the handlebar left and right at the maximum, to check if the idle increase.

CLUTCH

Proper clutch lever play is 2-3 mm. Play increases with the clutch wear and thus requires adjustment.

When there is too much play, first try to adjust the level of the clutch lever.

Tighten the adjustment bolt to obtain the optimal play.

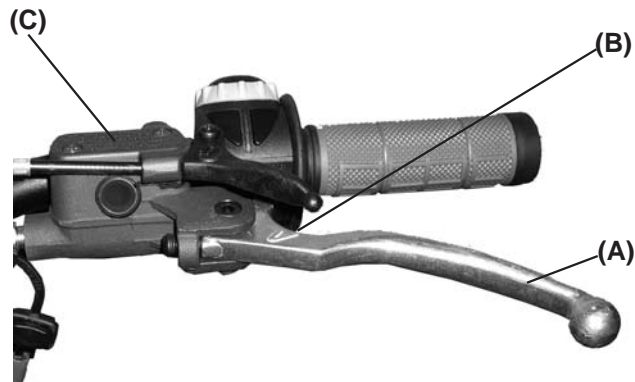

- (A). Clutch Lever.
- (B). Clutch cylinder piston rod.
- (C). Hydraulic fluid tank.

If the adjustment of the clutch lever has reached its limit, then play must be adjusted by the clutch cylinder piston rod.

THE EXHAUST SYSTEM

The exhaust and the silencer reduce noise and carry the gasses away from the driver.

If the exhaust is damaged, rusted, dented or split then change it. Change the silencer packing if the noise begins to be too loud or if the engine performance drops.

Changing the silencer

- Release the exhaust flange.

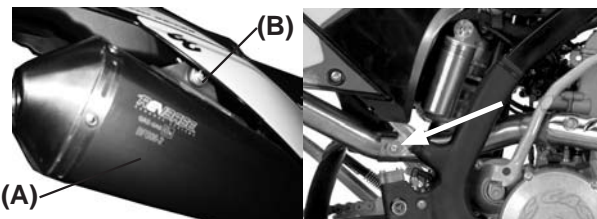

- (A). Silencer.
- (B). Silencer attachment bolts.

Changing the silencer packing

- Remove the cover rivets **(A)**.
- Extract the silencer cover **(B)**.
- Pull out the inner silencer.
- Change the silencer packing by wrapping around the inner tube.
- Refit the assembly.

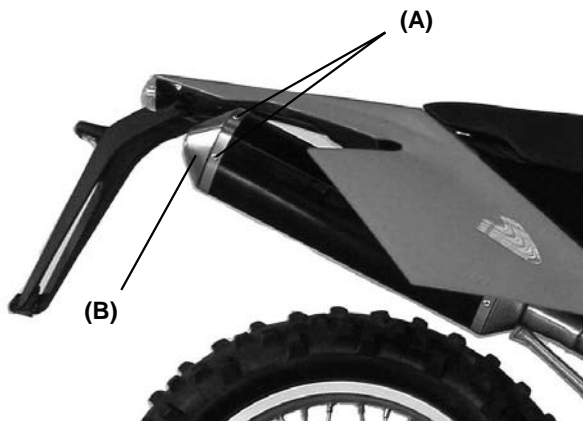

(A). Rivets.
(B). Cover.

CHAIN GUIDE

The drive chain must be checked, adjusted, and lubricated in accordance with the Periodic Maintenance table in order to prevent excessive wear. If the chain is worn or badly adjusted (to tight or loose) then it may jump off the sprockets or break.

WARNING

A chain that breaks or jumps off the sprockets could snag on the engine sprocket or lock the rear wheel, severely damaging the motorcycle and causing it to go out of control.

Checking tension

The space between the chain and the swing arm at the rear of the chain slider should be 30-50 mm. Rotate the rear wheel to find the place where the chain is tightest. Adjust the drive chain if it has too much or too little slack.

NOTE

In muddy or humid conditions, the mud gets inside the chain increasing tension and may cause the chain to break. To prevent this, adjust the chain to 30-50 mm of space between the chain and rocker arm whenever necessary.

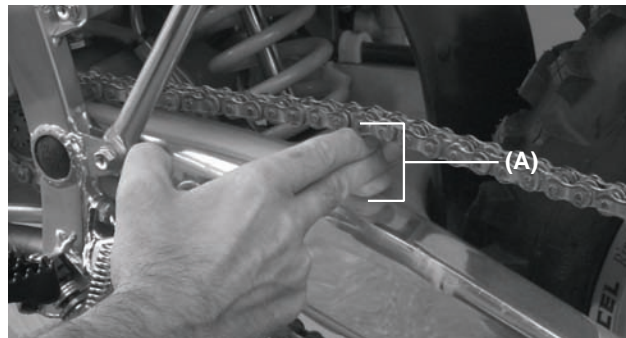

(A). 30 - 50 mm.

In addition to checking the slack, rotate the rear wheel to inspect the drive chain and sprockets for damaged rollers, loose pins and links, unevenly or excessively worn and damaged teeth.

TENSION ADJUSTMENT

- Loosen the rear axle nut.
- Turn the nuts on the chain adjusting bolts evenly until there is 30-50 mm of space between the chain and the swing arm. To keep the chain and wheel aligned, the adjustment on the left of the chain should be equal to that on the right.

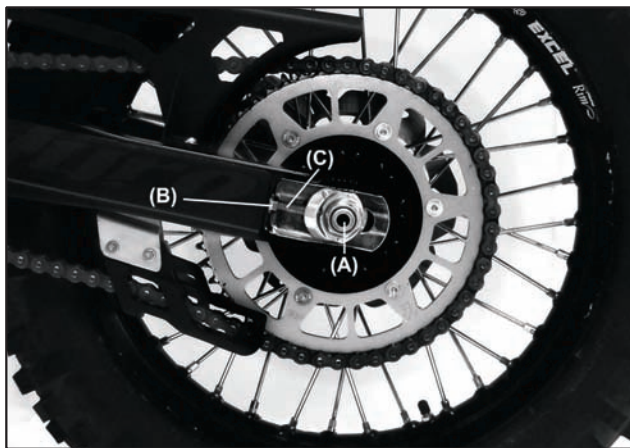

- (A). Rear axle.
- (B). Adjustment nut.
- (C). Chain adjustment.

NOTE

Wheel alignment can also be checked using the straightedge or string method.

WARNING

Misalignment of the wheel will result in abnormal wear and may result in an unsafe riding condition.

- Tighten the chain adjustment nuts.
- Tighten the axle nut to 98 N-m.
- Rotate the wheel, measure the chain slack again at the tightest position, and readjust if necessary.

WARNING

If the axle nut is not securely tightened unsafe riding conditions may result.

Drive chain, chain guide, chain slide, and rear sprocket

When the chain has worn so much that it is more than 2% longer than when new, it is no longer safe for use and should be replaced. Whenever the chain is replaced, inspect both the engine pinion and rear sprocket, and replace them if necessary. Worn teeth will cause the chain to wear more quickly.

NOTE

For maximum resistance and safety, a genuine part must be used for replacement.

To minimize any chance of the master link coming apart, the master link clip must be installed with the closed end of the «U» points in the direction of chain rotation.

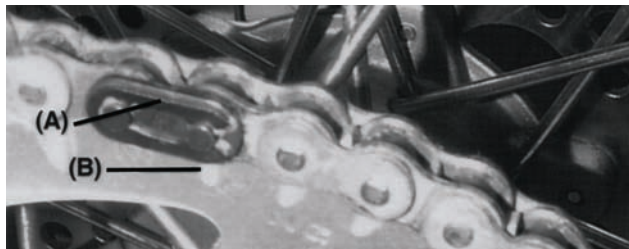

(A). Clip.
(B). Chain direction of rotation.

Chain Wear Guide

Visually inspect the drive chain wear guide (A); if the guide is worn excessively or damaged, replace it.

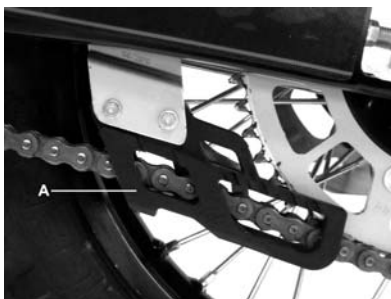

Chain guide slide

Visually inspect the upper and lower part of the chain slider on the swing arm. If this is worn then replace it.

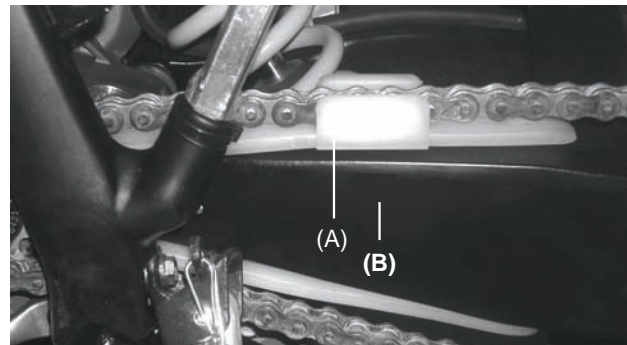

(A). Chain guide slide.
(B). Rocker arm.

Pinion and sprocket teeth wear

Visually inspect the pinion and sprocket teeth. If they are worn or damaged, replace the pinion or sprocket.

Lubrication

Lubrication is necessary after riding through rain or in the mud, or any time that the chain appears dry. A heavy oil is preferred to a lighter oil because it will stay on the chain longer and provide better lubrication.

Apply oil to the side of the links so that it will penetrate better. Wipe off any excess oil.

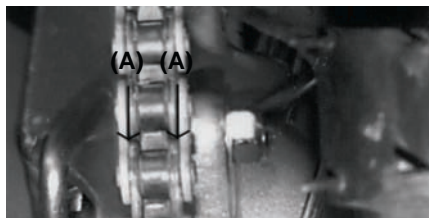

(A). Apply oil.

HANDLEBARS

To suit various riding positions, the handlebar position can be adjusted front to rear.

Handlebar position adjustment

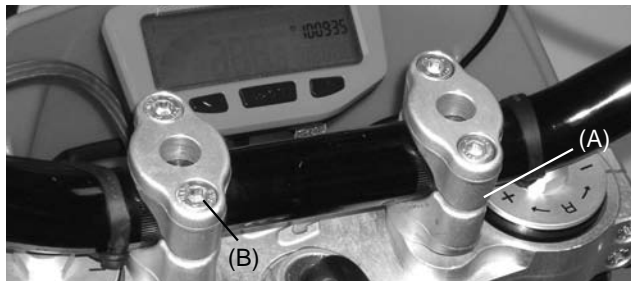

Loosen the handlebar holder bolts (B), of the handlebar holder (A) then rotate bars to desired position.

Tighten the bolts securely; first the forward bolts then the rear, to a torque of 25 Nm. If the handlebar is correctly installed, there will be a minimal gap at the front and rear of the clamp after tightening (A).



BRAKES

Disc and disc pad wear is automatically compensated for and has no effect on the brake lever or pedal action. So there are no parts that require adjustment on the brakes except brake lever play and the brake pedal position and play.

Front brake lever

Adjust brake lever to a comfortable position. To adjust, loosen the nut under the rubber protection (B). Tighten after adjustment. Ensure that the brake responds correctly.

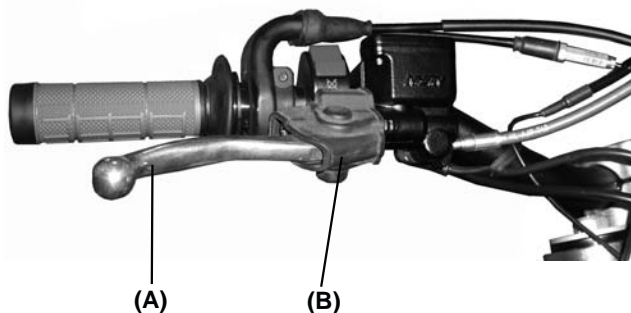

(A). Brake lever.
(B). Rubber protection.

Rear brake pedal

When the brake pedal is in rest position, there should be a play of 10 mm. If not, then adjust this. Ensure that the brake responds correctly and does not rub. To adjust the pedal play, loosen the locknut, rotate the bolt and retighten the locknut.

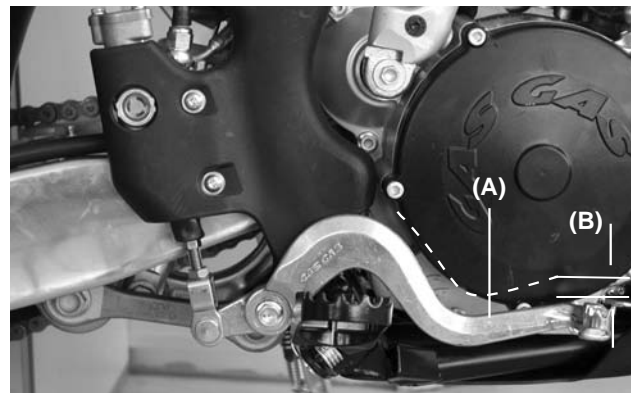

(A). Brake pedal.
(B). 10 mm of play.

WARNING

If the brake lever or pedal feels mushy when it is applied, there might be air in the brake lines or the brake may be defective. Since it is dangerous to operate the motorcycle under such conditions, check the brakes immediately.

Brake fluid

Regularly check the brake fluid and periodically change it. It should also be changed if it is contaminated by water or dirt.

Recommended liquid

Use D.O.T 3 or D.O.T 4

Fluid level inspection

The front **(A)** and rear **(B)** reservoirs must be kept more than half full with brake fluid. If the amount of brake fluid is insufficient, add brake fluid.

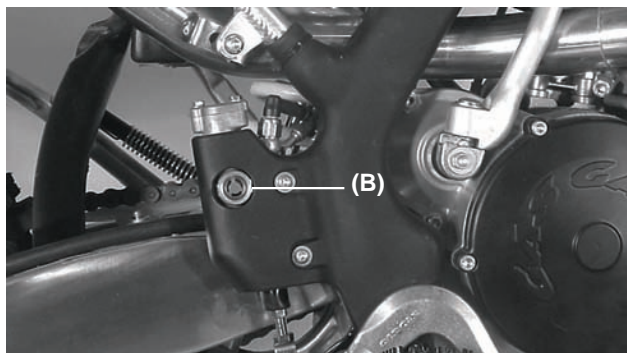

CAUTION

Do not spill brake fluid onto any painted surface. Do not use fluid from a container that has been left open or that has been unsealed for a long time. Check for fluid leakage around the fittings. Check for brake line damage.

WARNING

Do not mix brands of fluid. Change the brake fluid in the brake line completely if the brake fluid must be refilled with a type other than the brake fluid already in the reservoirs.

Brake Wear Inspection

If the thickness of either pad is less than 1 mm, replace both pads in the calliper as a set. Pad replacement should be done by an authorized GAS GAS dealer.

STEERING

The steering should always be kept adjusted so that the handlebar will turn freely but without excessive play.

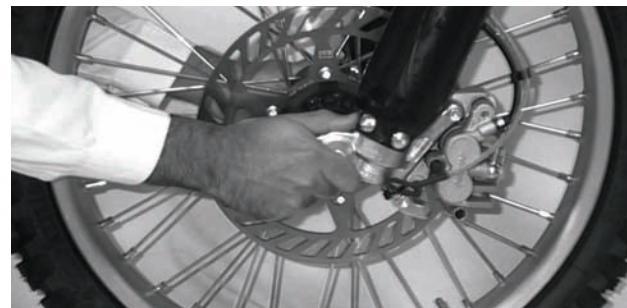

To check the steering adjustment, lift the bike off the ground using a stand underneath the chassis. Push the handlebar lightly to either side; if it continues moving under its own momentum, the steering is not too tight. Squatting in front of the motorcycle, grasp the lower ends of the front fork at the axle, and push and pull the bottom end of the front fork back and forth; if play is felt, the steering is too loose.

If the steering needs adjustment

- Using the stand under the frame, stabilize the motorcycle.
- Place a stand or block under the engine to raise the front wheel off the ground.
- Remove the foam protector.
- Remove the handlebar by loosening the handlebar clamp bolts (A).

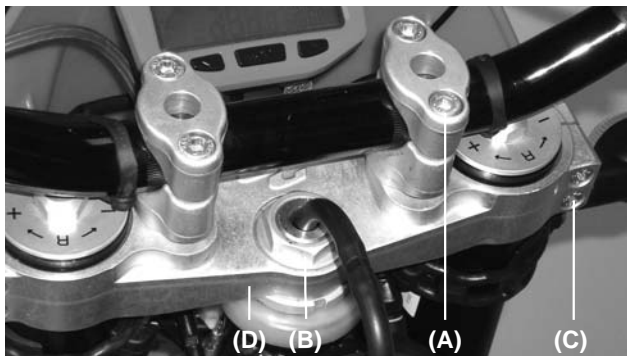

- Loosen the steering stem bolt (B).
- Loosen the bolts for the upper suspension plate and remove it (C).
- Rotate the steering adjustment bolt using the special spanner in order to obtain the appropriate adjustment.

- Install the upper suspension plate (D).
- Tighten the steering stem nut (B), the washers and bolts on the front forks to the correct torque.

Steering head nut: 44 Nm (4,5 Kgm)
Suspension plate bolts: 15 Nm (1,5 Kgm)

- Recheck the steering and readjust if necessary.
- Refit all removed parts.

STEERING LOCK

This mechanism allows us to lock the steering. It is located on the steering tube.

The handlebars must be turned to the right completely, then insert the key, rotate left, press, rotate right and take the key out.

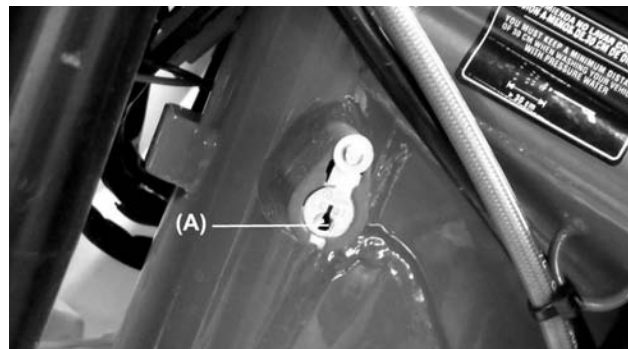

(A). Steering lock.

CAUTION

Never leave the key in the latch. If the steering is turned to the left with the key inserted in the latch it will be severely damaged.

FRONT FORK

The front fork should always be adjusted for the rider's weight and road conditions. The adjustments must be performed in 4 steps:

- Air pressure: Air pressure affects the fork travel. The air pressure increases as the fork heats up, in other words it varies as a function of time of operation. We do not recommend using air pressure, because the suspension has been designed to work without air pressure.
- Rebound and compression dampening adjustment: Turn the adjusting screws clockwise to increase damping, turn it counterclockwise to reduce damping.
- Oil level adjustment: The effects of higher or lower fork oil level are only felt during the final 100 mm of fork travel. A higher oil level will make the fork rebound faster. The lower the oil level is the fork rebound will be slower.
- Fork spring: Optional springs are available that are softer and stiffer than standard. There is also the possibility to adjust the spring preload.

Air Pressure

The standard air pressure in the fork is atmospheric air pressure. The air pressure increases as the fork heats up, because of this the fork action becomes harder.

- Using a stand under the frame, and stabilize the motorcycle.

- Place a support under the engine so that the front wheel is raised off the ground.
- Remove the purge screw (A) at the top of the front fork to bleed the air out.

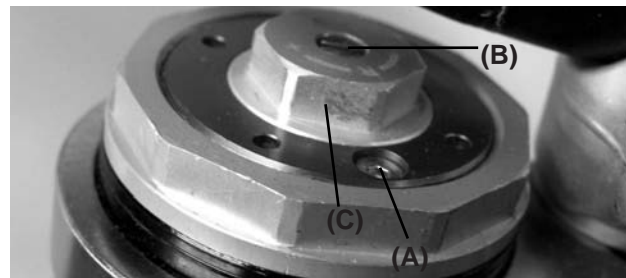

Rebound dampening adjustment MARZOCCHI Ø48

- To adjust the rebound, turn the adjusting screw located at the bottom of the front fork.
- Adjust the rebound to suit the rider's preference under determined conditions.
- Use the standard settings to adjust the rebound (turn it 20 positions counterclockwise).

CAUTION

The left and right fork tubes must be at the same level and aligned with the top bridge.

Compression dampening adjustment MARZOCCHI Ø48

- To adjust the compression, turn the adjusting screw located at the top of the front fork (B).
- Adjust the compression to suit the rider's preference under determined conditions.
- Use the standard settings to adjust the compression (turn it 20 positions counterclockwise).

Suspension tube spring

Different springs are available in accordance with the rider's weight or the road conditions.

- Harder springs make the fork stiffer, and rebound action quicker.
- Softer springs make the fork softer, and rebound action slower.

Preload: turn adjusting screw (C) counterclockwise as far as it will go. See page 33.

MZ 48: turn clockwise 1 turn.

Suspension top bridge position adjustment

Make sure the front tire does not rub against the fender when the fork tubes are compressed fully. Make this adjustment to a minimum of 5 mm.

CAUTION

The suspension tubes, both right and left, must be adjusted evenly.

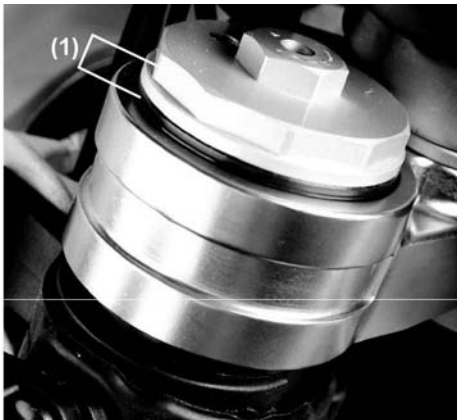

(1). Suspension top bridge position.

REAR SUSPENSION

The rear suspension is composed of the shock absorber, swingarm, linkages and torque rod.

Generally speaking, the operating characteristics are similar to the front fork. But its unique characteristic is that it has, besides the shock absorber, an articulated quadrilateral composed of the linkages and torque rod.

To match various riding condition types, the shock absorber spring can be adjusted or replaced with an optional one. Also the dampening force can be easily adjusted, this feature makes it unnecessary to change oil viscosity.

Shock absorber extension adjustment

To adjust, turn the extension adjuster in the lower part of the shock absorber until a "CLICK" is heard.

Rebound adjustment standard measures: 16 "CLICKS". (Counterclockwise from fully closed position).

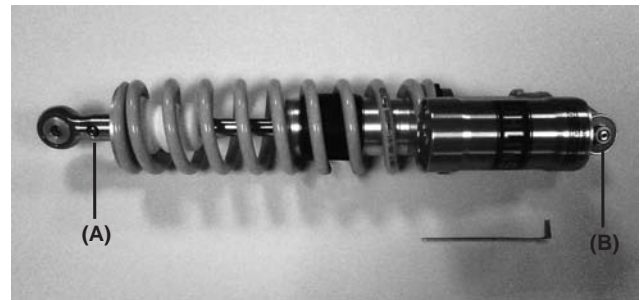

(A). Extension adjustment.

High compression adjustment

To adjust, turn the extension adjuster in the top part of the shock absorber until a "CLICK" is heard.

As the control is closed the compression will be harder, on the other hand as it is opened it will be softer.

Normally, the standard measurement would be 24 clicks from the completely closed position.

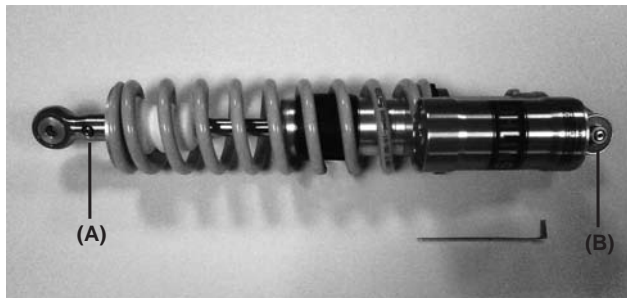

(B). Compression adjustment.

Spring adjustment

- Remove the seat and side covers.
- Loosen the air cleaner duct clamp screw.
- Remove the muffler.
- Remove the subframe with the air cleaner box.

Suspension spring

The standard spring is 5,2.
Preload: 10 mm.

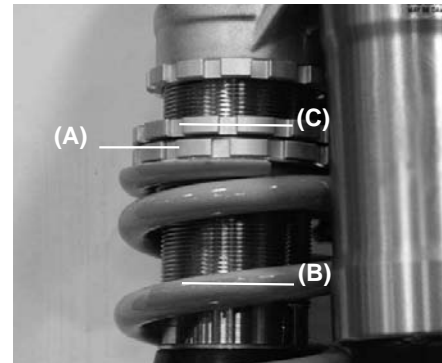

(A). Nut.
(B). Spring.
(C). Locknut.

- Tighten the locknut securely.
- After adjustment, move the spring up and down to make sure that the spring is fully seated.
- Install the parts removed.

Rear shock absorber spring replacement

Harder and softer springs are available. If the standard spring is not adequate for your purpose, select a proper one according to the rider's weight and the road conditions.

- Using the harder spring: The rebound is quicker.
- Using the softer spring: The rebound is slower.

NOTE

Refer to the suspension adjustments on page 44.

WARNING

Improper removal of the spring from the rear shock absorber body may cause the spring and associated parts to be ejected at high velocity. Always wear eye and face protection. Removal and installation of spring should be performed by an official distributor.

WHEELS

Tyre

- . Tyre pressure affects traction, handling, and tyre life.
- . Adjust the tyre pressure to suit track conditions and rider preference, but do not deviate excessively from the recommended pressure.

NOTE

Tyre pressure should be tested when the tyre is cold before driving.

Track conditions

- When the track is wet, muddy, sandy or slippery, reduce the tyre pressure.
- When the track is stony or hard, increase the tyre pressure.

Spokes and rims

The spokes on both wheels must all be tightened securely and evenly and not be allowed to loosen. Unevenly tightened or loose spokes will cause the rim to warp, hasten nipple and overall spoke fatigue, and may result in spoke breakage.

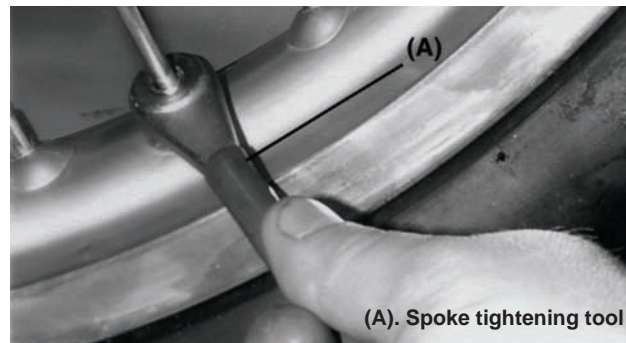

Centring the rim

Put a quadrant gauge next to the rim and rotate the wheel to measure the axial centring.

Put the dial on the inside of the rim circumference, rotate the wheel and the difference between the largest and smallest measurement is the centring measurement.

If the wheel is slightly off-centre then this can be corrected by loosening certain spokes and tightening others in order to change the rim position. If the rim is bent or crooked then it must be replaced.

NOTE

A soldered area on the rim may give an excessive reading. Ignore this while measuring the centring.

CLEANING**1- Preparation for cleaning**

Before cleaning the motorcycle must be prepared so that water does not penetrate certain areas of the bike.

The exhaust: Once this is cold, cover it with a plastic bag attached with rubber.

Clutch and brake levers, grips and stop button: cover with a plastic bag.

Air filter intake: cover this with insulation tape or a cloth.

2- Where to be careful

Avoid spraying water with any great force near the following places: Disc brake master cylinders and callipers; under the fuel tank (If water gets into the ignition coil or into the spark plug cap, the spark will jump through the water and be grounded out; the affected parts must be dried).
Front and rear hubs.
Steering pivots (steering tube).
Rear suspension system.
Swing arm pivots.

3- After cleaning

- Remove the plastic bags and clean the air filter intake.
- Lubricate the locations listed in the lubrication section.
- Start the engine and let it heat for 5 minutes.
- Check the brakes before driving the bike.

WARNING

Never wax or lubricate the brake disk, this could lead to brake failure and could provoke an accident. Clean the disk using trichloroethylene or acetone.

TIGHTEN BOLTS AND NUTS

Every day before using the bike, rapidly ensure that all bolts and nuts are tightened. Also make certain that all of the other fastenings are in place and in good condition.

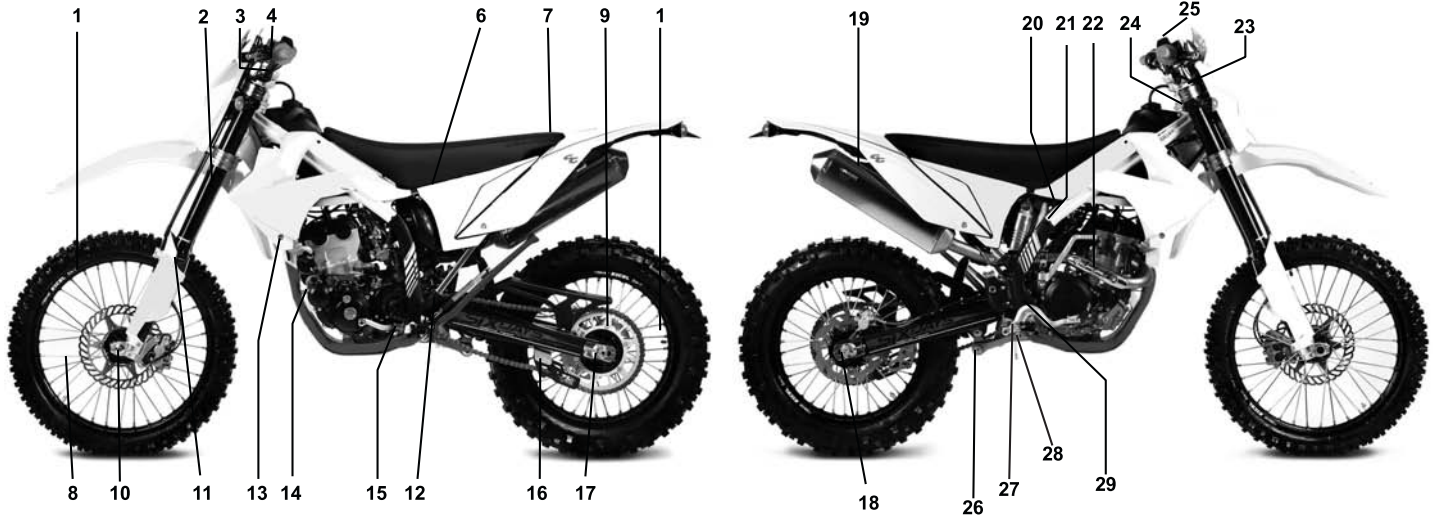

- 1- Front and rear wheels
- 2- Front forks
- 3- Handle bars
- 4- Clutch lever support bolt
- 6- Air filter housing bolts
- 7- Seat support bolts
- 8- Spokes
- 9- Disk plate screws

- 10- Front axle bolt
- 11- Brake attachment bolt
- 12- Sub chassis support bolt
- 13- Radiator support bolts
- 14- Nuts and bolts of the engine mounting
- 15- Shift pedal bolts
- 16- Chain guide bolts
- 17- Chain adjust bolt

- 18- Rear axle bolt
- 19- Silencer support bolts
- 20- Sub chassis bolts
- 21- Rear shock bolts
- 22- Exhaust flange bolt
- 23- Upper suspension plate bolts
- 24- Steering head nut
- 25- Brake lever support bolt
- 26- Rod support bolt

- 27- Rear brake pedal bolt
- 28- Rod support bolt
Rocker
- 29- Rocker arm bolt

TIGHTENING TORQUE TABLE

Tighten all of the bolts and nuts using the correct spanners. If not correctly tightened then motorcycle damage or even an accident could occur.

	PART NAME	Nm	Kgm
E N G I N E	Engine drain plug	20	2,0
	Kick pedal bolt	20	2,0
	Kick pedal nut	25	2,5
	Shift pedal bolt	10	1,0
	Spark plug	11	1,0
	Water pump cover drain plug	13	1,3
C H A S S I S	Calliper mounting bolts	25	2,5
	Disc plate mounting screws	10	1,1
	Engine mounting bolts	36	3,6
	Front axle bolt	51	5,1
	Front brake lever support bolt	6	0,6
	Fork flange bolt	15	3,0
	Steering nut	98	10,0
	Rear axle nut	98	10,0
	Rear brake pedal bolt	9	0,9
	Sub frame support bolt	26	2,7
	Rear shock absorber bolt	39	4,0
	Rear disc wheel drive bolt	29	3,0
	Spokes	1,5	0,15
	Steering axle bolt	4	4,5
	Rocker arm bolt	81	8,3
Rod bolt	81	8,3	

LUBRICATION

Lubricate the points shown here, with either motor oil or regular grease, periodically or whenever the vehicle is wet, and especially after using a high-pressure spray washer. Before lubricating each part, clean off any rusty spots with rust remover and wipe off any grease, oil, dirt, or grime.

General lubrication

- Clutch lever (A).
- Front brake lever (B).
- Rear brake pedal (C).
- Rear brake bearing (D).
- Shift pedal (E).

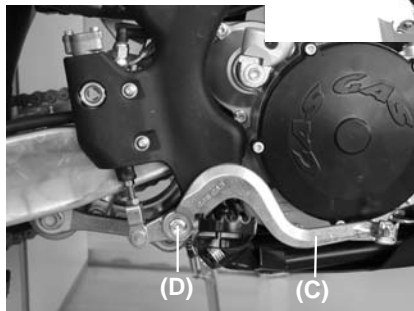

Use an aerosol with a pressure tube to lubricate

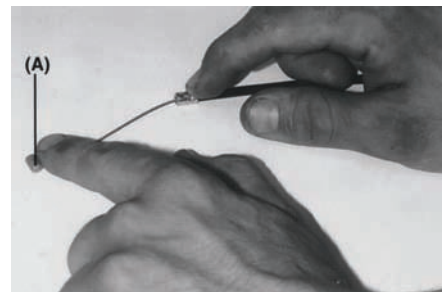
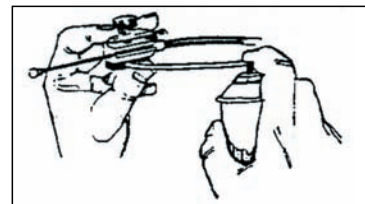

Use grease on the inner throttle cable

Chain lubrication

Lubricate the chain after wet terrain or when the chain looks dry. A high viscosity oil rather than low viscosity oil is better because it will stay a long time in chain providing lubrication.

Put oil on the sides of the chain rollers (A) so that it penetrates into these; remove excess oil.

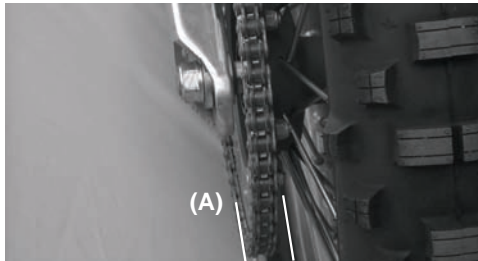

(A). Greasing.

ENGINE OIL

Use a premium 4-stroke engine oil to lengthen the life of your motorcycle. We recommend to use the type SG oil with the classification API.

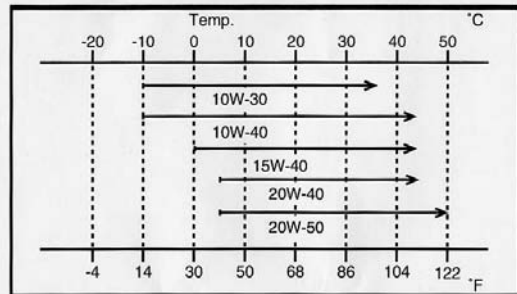

The recommended viscosity is SAE 5 W-40. If it's not possible, look at the lower table to find another viscosity.

Checking the oil level and making the changes periodically are two very important operations to keep the engine in perfect shape.

After 5 hours of running of a new bike, remove and change the oil and the oil filter. After that, you must change the oil every 10 hours or 500 kms.

NOTE

The engine oil expands and thus the level increases when it is hot.

Check and adjust the level when the motor oil is not hot.

Changing the oil and filter

The oil should be changed when the engine is hot, since this helps the oil to go out through the drain located in the lowest part of the engine.

WARNING

The engine oil and the exhaust manifold can be very hot and cause burns.

Wait until the oil and the exhaust manifold are a little cooler.

WARNING

Engine oil is a health risk. Avoid any contact with this given that this could provoke irritations and, in the worst cases, skin cancer.

- Keep new or used oil away from the reach of children and animals.
- Clean clothes sleeves and pants.
- Wash yourself with soap if oil has been in contact with your skin.

To change the oil, follow the following steps:

1. Place a recipient underneath the crankcase.

NOTE

Put used motor oil in an appropriate container for recycling.

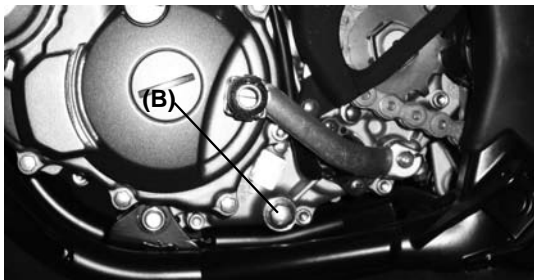

2. With the motorbike parked on a flat surface, empty the engine oil from the sump by removing the plug (B).

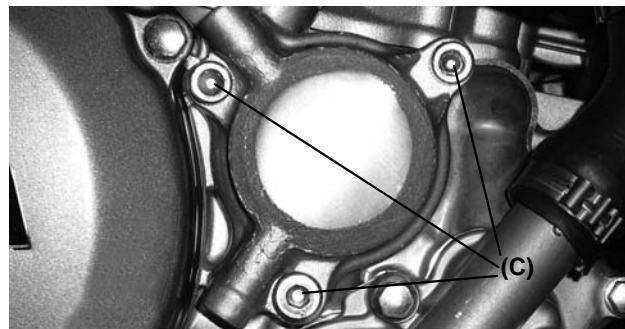

3. Pull out the filter cover screws.(C).

WARNING

Always use original GAS GAS parts.
If the filter is incorrectly positioned, the engine oil will not flow, provoking a malfunction in the engine.

. During the oil filter change, check the o-rings and change it if you find a problem (crack)



5. Replace the filter cover and put the screws that secure the cover, but without tightening them too hard (do not exceed the recommended torque).

6. Put the oil cap on the carter and lock it. By the flywheel carter hole, introduce 1.300 ml of oil. **(H)**

WARNING

The engine may be damaged if the oil is not used properly or the specifications recommended by GAS GAS MOTOS are not followed. Use the type of oil specified in the section on Petrol and Oil recommendations.

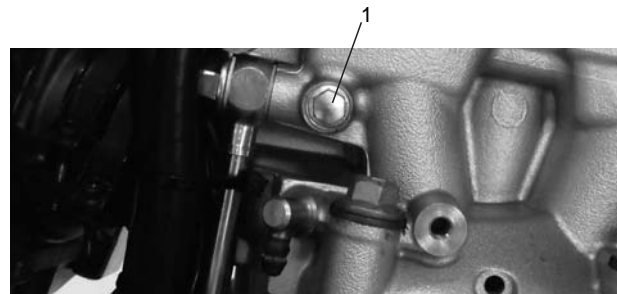

7. Unlock the pression control screw 1
 - Start the engine and stay at the idle to check if the oil is coming by this pression control screw.
 After 1 min, if the oil is not coming, stop the engine.
 -Check if the oil tub or the oil pump are not block and check the etancheity.-
 -After the solving problem, check again the oil pressure.
 - Lock the pression control screw at 10 Nm.

8 .Remove the oil level screw K, the oil must exit by this hole when the bike is straight.



11. If more oil is needed it can be topped up through the opening in the ignition cover **(H)**.

TUNING THE SUSPENSION

No area of machine adjustment is more critical than proper suspension tuning; an incorrectly tuned suspension will keep even the best rider from attaining the full benefit of his machine's ability. Check the suspension according to the pilot and the conditions of the terrain. When tuning the suspension don't forget:

- If the machine is new, break-in the suspension with at least one hour of riding before making any setting evaluations or changes.
 - The major factors which must be considered in suspension tuning are: rider weight, rider skill and the track conditions (as well as the rider's style and positioning on the machine)
 - If you have a problem, test by changing your riding posture or position so that the cause of the problem can be deduced.
 - It is a wise practice to adjust suspension settings to suit the rider's strong points. If you are fast through the corners, adjust the suspension to allow fast cornering.
 - Make setting changes in small increments; a little bit goes a long way, and it is very easy to over adjust a setting.
 - The front and rear suspension should be balanced; when one is changed, the other should be changed similarly.
- When evaluating suspension performance the rider must make every effort to ride consciously and recognize the effects of his changes; such things as changes in rider position and increasing fatigue may lead to incorrect judgments about required setting adjustments.
- When the proper settings have been determined for a particular track, they should be written down for reference when returning to that track.
 - Lubricate the bearings of the swinging arm, rods, rocker and joints before making changes and every 5 refills to prevent excess friction affecting the operation of the suspension.

Front forks

The fork oil level is adjustable. A change in the oil level will not affect the lower part of the stroke, but it will affect the upper part.

- When the oil level is raised:

The spring effect becomes more progressive, and the front fork action feels 'harder' in the later stage of travel, near the bottom of the stroke.

- When the oil level is lowered:

The spring effect becomes less progressive, and the front fork action feels softer near the bottom of the stroke.

- Change the fork oil level correctly to make the forks work more at the end of fork travel.

- If fork bottoming is experienced, raise fork oil level in 10 mm increments. This increase will cause a change in the upper stroke of the spring.

Adjusting the oil level

Adjust the oil level of the front forks (see the maintenance chart).

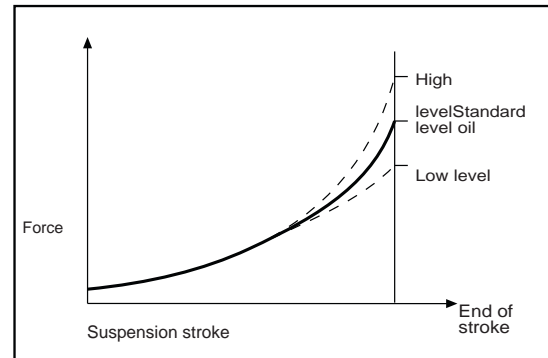

Changing incorrect adjustments

Listed below are some symptoms of improper suspension settings and the most adequate means of correcting them.

The proper settings can be achieved by applying the information in this chapter in a scientific manner. Simply take time to think about the changes you believe necessary, check them against the symptoms and cures described here, make the changes in small increments, and take notes on the changes and their effects.

Front fork symptoms

- The front forks are too stiff

- . Rebound adjustment incorrect.
- . The springs are too strong.
- . Too much oil.
- . Oil too dense.

- The front forks stiffen at the end of the stroke

- . The fork oil level is too high.

- The front forks operate but ride is too hard

- . Oil too dense.
- . Fork oil degraded

- Too soft

The front forks dive excessively during braking and deceleration

1. Front fork oil level low.
2. The springs are too soft.
3. Oil too light.
4. Fork oil degraded.
5. Rebound compression incorrect.

Rear shock absorber symptoms

- Too hard

1. Rigid suspension.
 - . High compression.
 - . Hard spring.
2. Hard driving.
 - . Imbalance between the spring and rebound (too low).
3. The spring is hard or very preloaded

- Too soft

On landing after a big jump, bottoming occurs.

- . Spring too soft or compression damping is too soft
- . Shock oil degraded.

Determining the Proper Settings

- Standard adjustments

From the factory, the machine is set up for an intermediate-weight rider possessing intermediate riding ability. If the rider weight or ability is greater or lower than average then some adjustments may be made to the suspension.

- Readjusting the suspension

Type of surface	
Smooth	Soft spring
Rough	Hard spring

Experience

Beginner: softer spring with more rebound damping.
Experienced: Harder spring.

Weight

Heavy: harder spring.
Light: soft spring

Track type

- Many corners:

Lower the front end slightly (increase the fork tube height 5mm).
This increases agility.

- Fast course with many jumps:

Lift the front (lower the fork tube height to 5mm). This increases stability.

- Deep pits or sandy ground:

Lift the front for increased stability.

Following the preliminary adjustments, make a trial run on the ground to evaluate the changes.

Remember:

- 1- Always make changes in small increments.
- 2- Make sure the rider is logical in their evaluation.
- 3- A change in the front suspension requires a change in the rear suspension and vice-versa.

Front and rear compatibility

Use this procedure to determine if the suspension is balanced reasonably well: Situate the motorcycle so that it is perpendicular to the ground. While standing next to the machine, pull on the front brake and place one foot on the brake firmly. If the bike maintains its level attitude as the suspension is compressed, the suspensions are well balanced. Sit astride the bike and take up a riding posture the check to see if the bike is in a horizontal position. If one end drops noticeably more than the other, the front and rear are not compatible and must be readjusted to achieve a better balance.

This is one of the most effective adjustment procedures but suspension settings will vary depending on the conditions at the track and the rider's preferences.

Front end searching going downhill or accelerating out of a bend ?

Front forks too soft.

1. Increase the compression damping or rebound damping.
2. Increase the oil level 10 mm.
3. Use alternate harder spring, or increase spring preload.

Front end knifes or over-steers in turns (front end tends to turn inward)?

Front forks too soft.

1. Increase the compression damping or rebound damping.
2. Increase the oil level 10 mm.

Front end pushes out or slides in turns

1. Decrease the compression damping or rebound damping.
2. Release air from the fork.
3. Reduce the oil level 10 - 20 mm.
4. Use a softer spring.

Front fork doesn't respond to small potholes in wide turns

- Front fork hard:

1. Decrease the compression damping or rebound damping.
2. Reduce the oil level 10 mm.
3. Use a soft spring.

Rear end kicks when braking on potholes

The shock probably has too little rebound damping.

- Increase the rebound damping.

Rear tire won't "hook up" out of corners

(A loss of traction coming out of turns).

- The shock is too stiff:

1. Reduce rear shock absorber spring.
2. Reduce compression.
3. Use a softer spring.

Landing on front wheel in fast jumps

(could also be a rider position problem).

- Rebound too soft or spring too hard:

1. Increase rebound.
2. Reduce preload of the shock spring.
3. Reduce compression.

Front and rear of the bike bottom off high speed jumps:

(If harsh bottoming occurs once or twice per lap of the race).

. Front and rear suspension system are too soft:

1. **Front** : Increase oil level and/or use harder spring.
2. **Rear**: Use a stronger spring and / or increase compression.

NOTE

After any adjustment, check front and rear compatibility.

Adjustments depending on the bottoming of the suspension (rear shock).

- Bottoms at low speed: Increase spring preload to maximum.
- Bottom after successive 3 or 4 successive jumps.

NOTE

The rear shock on this machine, due to its adjustment possibilities, could confuse some riders.

a) The rear shock does not bottom out when the spring and damping are correct for the total weight of the machine and rider (full stroke).

b) A bottoming sensation (even through the machine is not bottoming) may actually be the inability of rider and machine weight to overcome an overly stiff spring or excessive damping.

Observe the rear while jumping; if it does not approach the limit then attempt to lower the spring preload.

Gears**Selecting the development. Preconditions.**

Track conditions: vary the transmission by changing the rear sprocket.

Fast track: Sprocket with lower number of teeth.

Bends or sandy/soft hills: sprocket with more teeth.

- If the time trial is long then the development may be longer for increased speed.

- When the time trial of the course has many curves, hills or is wet, the development is decreased so that gear shifting is possible at low speeds.

-As a result gears can be changed depending on the terrain on the day of the race. Ensure to correctly adjust the machine in order to run the entire race.

- If the straight portion of a course on which the machine can be run at maximum speed is longer, the machine should be set so that the maximum speed can be developed all the way to the end of the straight course, but care should be taken not to over-rev the engine

- It is difficult to adapt the machine to the entire circuit, for this reason it is necessary to determine the sections that have more effect on time and to adapt the motorcycle to these parts. This strategy means that the machine will gain overall track performance.

Special care according to track conditions

1. In dry, dusty conditions (such as volcanic ash or fine powdery dust) special care must be given to keep the air cleaner element clean.
2. Wet heavy clay or mud sticking to the tyres and other parts of the vehicle. The mud can add significantly to the weight if the vehicle obstructing the radiator and therefore reduce performance. Take care not to overheat the engine. The same applies to deep sand.
3. In muddy or sandy conditions adjust the chain looser than in other conditions as the chain and sprockets will pack with mud/sand and reduce chain slack.
4. Check chain and pinion/sprocket wear frequently when riding in mud or sand since wear is increased in these conditions
5. In dusty conditions as the air cleaner collects dust, the engine runs richer.

SPARE PARTS AVAILABLE

Your Gas Gas dealer will provide any information you may require about spare parts.

DURING COMPETITION

(1). Check

1. Tighten the front axle and disks
2. Tighten the front forks flange bolts
3. Tighten the handlebar clamp bolts
4. Tighten the throttle control bolts
5. Verify, grease the throttle control
6. Verify the front and rear brake lines
7. Front and rear brake fluid level
8. Front and rear brake disc and calliper installation
9. Front and rear brake operation
10. Fuel tank installation
11. Check cables
12. Engine mounting bolts
13. Engine pinion
14. Shift pedal bolt
15. Transmission oil level
16. Battery charge
17. Carburetor
18. Rod mounting bolts
19. Rod bolts
20. Rear shock bolts
21. Tighten the swinging arm pivot nut
22. Tighten the rear axle nut
23. Tighten nut and bolt of rear sprocket
24. Operate rear brake pedal
25. Check seat
26. Tighten the spokes
27. Tyre air pressure
28. Tighten chain
29. Coolant Level

(2). Following a day of competition

1. Clean the air filter and change the oil filter and the engine oil.
2. Adjust the chain tension / slack
3. Tighten the bolts of the rear sprocket
4. Tighten spokes
5. Check the tyre pressure
6. Tighten the front and rear axle nuts
7. Tighten the swinging arm nut
8. Tighten the nuts and bolts of the exhaust and silencer
9. Tighten the nuts and bolts of the mudguard support
10. Tighten the nuts and bolts of the tank seat
11. Check the brakes
12. Check steering play
13. Fill the tank
14. Check the coolant level

(3) After racing on dusty terrain

If dirt or dust gets through into the engine, the crankshaft will wear excessively. After riding, inspect the crankshaft. If the crankshaft is worn past the service limit, replace the crankshaft with a new one.

(4) Maintenance notice for after riding in rain on muddy course

1. Apply grease to swing arm pivot and rear suspension system.
2. Inspect the drive chain and rear sprocket for wear.
3. Clean the pinion and rear sprocket.
4. Check the piston-cylinder and crankshaft bearing.
5. Grease the throttle control and cable.

(5) Suggested spare parts

Consult the parts manual.

STORAGE

When the motorcycle is to be stored for any length of time, it should be prepared for storage as follows:

Clean the entire vehicle thoroughly.

- Start the engine 5 minutes to warm the engine oil and then after remove it.

- Change the oil by a new one.

Empty the fuel from the fuel tank, and empty the carburettor float bowl. (If left in for a long time, the fuel will deteriorate).

- Disconnect the battery.

- Lubricate the drive chain and all the cables.

- Spray oil on all unpainted metal surfaces to prevent rusting. Avoid getting oil on rubber parts or in the brakes.

- Set the motorcycle on a box or stand so that both wheels are raised off the ground. (If this cannot be done, put boards under the front and rear wheels to keep dampness away from the tire rubber).

- Tie a plastic bag over the exhaust pipe to prevent moisture from entering.

- Put a cover over the motorcycle to keep dust and dirt from collecting on it.

To put the motorcycle back into use after storage.

- Remove plastic bag from exhaust.

- Make sure the spark plug is tight.

- Fill the fuel tank with fuel.

- Check all the points listed in the Daily Pre-ride Inspection Section.

- General lubrication

- Connect the battery.

GAS GAS MULTIFUNCTION INSTRUCTIONS

The multifunction apparatus, which is waterproof, has 2 LED indicators on a central indicator screen.

This central indicator screen, made of liquid crystal and with illumination, gives information about speed, distance travelled, total kilometres travelled, time, average speed, maximum speed, ambient temperature, length of time with motor running and total time. The odometer and the control for the total time with motor running save the data to the memory, even when the device is switched off. When the multifunction apparatus is not activated, it displays a clock. The value of the wheel circumference can be altered, as well as the system of measurement (metric or British).

The ambient temperature is displayed on the upper left-hand part of the screen.

The screen can display the engine temperature from an optional temperature sensor.



1. Yellow warning LED
2. Red warning LED
3. Right-hand button
4. MODE button
5. Left-hand button
6. Central display screen

Technical characteristics

FUNCTIONS	SYMBOL	TECHNICAL CHARACTERISTICS	INCREMENTS	PRECISION
CURRENT SPEED	SPD:	4 - 399.9 kmph or mph	0.1 kmph or mph	+/- 0,1%
TIME RUNNING	TT	0 - 9999 hours 59 minutes	1 second	+/- 0.1%
ODOMETER	ODO	0.0 – 999999	1	+/- 0,1%
OPERATION TIME	RT	0 - 999 hours 59 minutes	1 minute	+/- 0.1%
OPERATION TIME ACCUMULATED	ART	0 - 9999 hours 59 minutes	1 minute	+/- 0,1%
CLOCK	00:00:00	12:59:59 or 23:59:59		+/- 0,1%
BATTERY LOW	LO	Approximately 1 year life		+/- 0,1%
TYRE SIZE		0 - 3999 mm		

Technical characteristics

Initial voltage: 9 - 400 V AC/DC..

Speed sensor: Non-contact magnetic sensor.

Wheel circumference adjustment: 1 mm – 3.999 mm (1 mm increments).

Battery / life: 3V CR2032 / Approx. 1 year

Functions

SPD: Speedometer

The speedometer information appears in the centre of the screen. It shows up to 399.9 kmph or mph.

MS: Maximum speed gauge

It shows the highest speed reached since the last resetting of the data.

DST: Distance travelled

This appears on the right side, in the second line of the screen. The TRIP function contains the vehicle's accumulated mileage since the last RESET operation.

ODO: Odometer

It shows the total mileage accumulated by the vehicle. The data is stored in the memory, even when the device is not running.

ART: Time of use controller

Calculates the total time in operation. It starts counting from the moment the motor is turned on.

RT: Total time of use controller

It calculates the vehicle's operation time since the last RESET operation. It starts counting from the moment that movement begins. The data is stored in the memory, even when the device is not running.

12/24 hour clock

It shows the time in either 12 or 24 hour formats.

Setting the multifunction display parameters

After confirming each value, the display goes from one screen to the next until all have been displayed. If no button is pressed, the display returns to the home screen after 15 seconds.

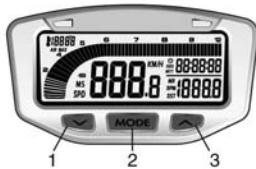

Activating adjustment mode

To start setting mode for the multifunction display, press buttons 1, 2, and 3 simultaneously for 3 seconds, and then release.



Selecting the speed unit

To change between kmph and mph, press button 1. Confirm the selection by pressing button 2.



Selecting the time format

To change between the 12 and 24 hour clock, press button 1. Confirm by pressing button 2.

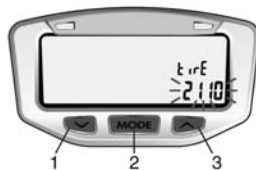

Selecting the values for the wheel circumference

Enter the value for the wheel circumference by pressing button 1 in succession. To go on to the next digit, press button 3. Confirm by pressing button 2.

Note:

If you do not know the value of the wheel circumference, see the section on "Measuring the wheel circumference"



Setting the time

Enter the value for the time by pressing button 1 in succession. To go on to the next digit, press button 3. Confirm by pressing button 2.

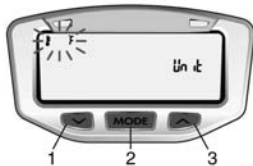

Selecting the temperature unit

To change the temperature display between °C and °F, press button 1. Confirm by pressing button 2.



Selecting the warning temperature

Note:

This step can only be taken on vehicles fitted with the optional temperature sensor.

When the engine temperature exceeds the set value, the warning LED on the left lights up.

Default value: 90 °C (190°F)

Enter the value by pressing button 1 in succession. To go on to the next digit, press button 3.

Confirm by pressing button 2.



Selecting the danger temperature

Note:

This step can only be taken on vehicles fitted with the optional temperature sensor.

When the engine temperature exceeds the set value, the warning LED on the right lights up.

Default value: 110 °C (230°F)

Enter the value by pressing button 1 in succession. To go on to the next digit, press button 3.

Confirm by pressing button 2.

Resetting the display functions after each use of the vehicle.

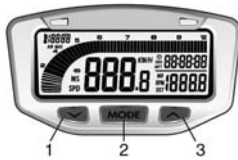

After each use of the vehicle, the following functions can be reset simultaneously:

- Maximum speed
- Distance
- Chronometer
- Maximum temperature

Confirm the reset by pressing buttons 1 and 2 simultaneously.

Total reset of the display

Press the RESET button, using a suitable object. The display will start from zero, except for the data for total accumulated distance and time.



Internal battery

The display is powered by an internal 3 V battery, type CR2032. When the voltage in the internal battery drops below 2.45V, the screen displays LO.

To change the battery, open the cover behind the display, and use a coin to unscrew it counter-clockwise. Make sure that the positive terminal on the battery is facing upward.

Screen options

The multifunction display shows all the information on three different screens.

While in motion, screens 1 and 2 are on display. Screen 3 is displayed for 3 seconds, and then returns to screen 1.

To change from one screen to another, press button 2 ("Mode") in succession.

To edit the distance travelled (DST), keep button 3 pressed down.

Screen 1:

Screen 1 shows the following information:

- Speed, distance travelled, time, ambient temperature.

Screen 2:

Screen 2 shows the following information:

- Speed, time in motion, time in operation, engine temperature*.

Screen 3:

Screen 3 shows the following information:

- Maximum speed, accumulated time in operation, odometer, maximum temperature*.

*Optional

Lighting

The display is powered by an internal 3 V battery, type CR2032.

To change the battery, open the cover behind the display, and use a coin to unscrew it counter-clockwise. Make sure that the positive terminal on the battery is facing upward.

When the display is powered by the internal battery only, the screen lights up partially for 3 seconds when the button is pressed.

If the lighting is connected to the 12V system on the vehicle, it will be brighter and stay on for up to 20 minutes after the vehicle has come to a full halt.

Sleep Mode

If the multifunction display does not receive any information for 20 minutes (signal from wheels turning or a button pressed), the screen goes off, showing only the time. When the vehicle starts or a button is pressed, it will start up again.

Measuring the wheel circumference

Method 1

Measures the diameter of the front wheel. Multiply the diameter by 3.14 and, if necessary, convert the measurement into mm by multiplying the figure obtained by 25.4. The measurement obtained is the size of the wheel circumference.

Method 2

On a smooth, flat surface, make a mark on the side of the tyre where it touches the ground. Move the vehicle forward until the tyre has made a complete turn, and the mark is back at the lowest point. Make a new mark on the ground at this point.

Measure the distance between the marks on the ground and, if necessary, convert the measurement into mm by multiplying the figure obtained by 25.4. The measurement obtained is the size of the wheel circumference.

To obtain a more precise measurement, the driver must remain on the vehicle while taking measurements.

FAULT DIAGNOSIS

NOTE

This is not an exhaustive list, it is meant simply as a rough guide to assist troubleshooting for some of the more common difficulties.

	FAULT	CAUSE	SOLUTION
1	The starter motor does not work	<ul style="list-style-type: none"> - The fuse for the starter relay is blown. - Battery discharged. - Low temperature. 	<ul style="list-style-type: none"> - Remove the seat and change the starting relay fuse - Charge the battery and if this one doesn't take it, go to a GasGas dealer -Start the engine with the kick pedal
2	The engine does not rotate	<ul style="list-style-type: none"> - Crankshaft locked. - Cylinder/ piston/ crankpin journal seizure. - Transmission assembly seizure. 	<ul style="list-style-type: none"> - Go to a specialist workshop. - Go to a specialist workshop. - Go to a specialist workshop.
3	Engine rotates but does not start	<ul style="list-style-type: none"> - Fuel supply incorrect. - The motorcycle has been out of operation for a longer period of time. - Spark plug soiled or humid. - Engine flooded. 	<ul style="list-style-type: none"> -check the fuel tub, remove the fuel tap to clean it and reassemble it correctly -remove the old fuel and change it, the engine would start immediately -Dry the spark plug or change it. -If the engine is drowned, you can press the hot starter and on the same time, press the Kick pedal 5 at 10 times or use the electric starter 2 times 5 seconds. When the engine is dry, you can start normally. If the engine don't start, dry the spark plug or change it.

	FAULT	CAUSE	SOLUTION
3	Engine rotates but does not start	<p>The CDI connector, the generator or the bobina are oxidised or disconnected.</p> <ul style="list-style-type: none"> - Petrol / gas mixture incorrect (Trim Epprom). 	<ul style="list-style-type: none"> - Clean the connectors and use a electric contact spray -Clean the venting tub from the fuel tank check the inlet system
4	The engine starts but does not stop	<ul style="list-style-type: none"> - Air supply incorrect. - Fuel insufficient. 	<ul style="list-style-type: none"> -Pull-out the starters. clean the venting tub from the fuel tank -Check the inlet system, check the fuel level
5	The engine overheats	<ul style="list-style-type: none"> - Insufficient coolant in the circuit. - The radiator is soiled or partially obstructed. 	<ul style="list-style-type: none"> - Add coolant, verify the cooling system seal. - Clean the radiator fins or change it.
6	The engine does not run smoothly	<ul style="list-style-type: none"> -Dry spark plug -Bad contact from the spark plug coil or the cable -Wrong valves clearance 	<ul style="list-style-type: none"> -Control of the spark plug, cleaning, adjustment or a new one -Check the spark plug cap or change it -Valve clearance adjustment, contact a GasGas dealer
7	The engine is under powerful or accelerates badly.	<ul style="list-style-type: none"> - Fuel supply faulty. - Air filter obstruction. - Exhaust deteriorated with leaks. - Valve set too small. - Decompression maladjusted. 	<ul style="list-style-type: none"> - Clean or change the air filter. - Check if the exhaust system is damaged, change the glass fibre in the silencer if necessary. - Adjust the valve play. Go to a specialist workshop. - Verify the operation of the system.
8	High oil consumption	<ul style="list-style-type: none"> - Piston-cylinder ring diameter tolerance excessive. 	<ul style="list-style-type: none"> - Adjust the tolerance by changing the piston rings.

	FAULT	CAUSE	SOLUTION
8	High oil consumption	<ul style="list-style-type: none"> - The quality or viscosity of the oil is insufficient. - Ignition problems. - Valve adjustment play. 	<ul style="list-style-type: none"> - Correct the engine oil level. Drain oil as necessary from the engine. - Empty the engine oil and fill with oil of the recommended viscosity.
9	Abnormal engine noise	<ul style="list-style-type: none"> - Over heating. 	<ul style="list-style-type: none"> - Go to a specialist workshop. - Adjust the valve play. Go to a specialist workshop. - See chapter 5.
10	Detonations in the exhaust	<ul style="list-style-type: none"> - Carbon in combustion chamber. -The carburator need to be adjusted - Incorrect or poor gasoline or wrong octane rating. - Incorrect or non-specified spark plug. - Exhaust system joints deteriorated. 	<ul style="list-style-type: none"> - Clean the combustion chamber. - Go to a specialist workshop. - Drain the petrol and fill with fresh or higher octane petrol. - Change spark plug for a new one or recommended one. - Check if the exhaust system is deteriorated. The seals must be in perfect condition, if not then they must be changed for new ones.
11	White fumes from the exhaust	<ul style="list-style-type: none"> - Cylinder head gasket leak (water leaking into cylinder). 	<ul style="list-style-type: none"> - Change the cylinder head gasket. Go to a specialist workshop.
12	Brown fumes from the exhaust	<ul style="list-style-type: none"> - Air filter obstruction. 	<ul style="list-style-type: none"> - Clean or change the air filter. Go to a specialist workshop.
13	The gears do not engage - There is too much engine oil.	<ul style="list-style-type: none"> - Clutch does not release. - Shift fork worn or locked. - Gear locked in transmission. - Shift lever damaged. - Selector position spring broken or loose. 	<ul style="list-style-type: none"> - Go to a specialist workshop. - Change the gear fork. - Go to a specialist workshop. - Change the gear lever. - Adjust the selector position spring or change it.

	FAULT	CAUSE	SOLUTION
13	Gears don't engage	<ul style="list-style-type: none"> - The spring of the selector is broken. - Cylinder change if broken. - Gear ratchet spring broken. 	<ul style="list-style-type: none"> - Replace the down selector mechanism spring. - Replace the gear drum. - Replace the ratchet spring of the selector.
14	Gears jump	<ul style="list-style-type: none"> - Gear change fork damaged in the gears. - Gear teeth worn. - Gear nipple damaged. - Groove gear drum worn. - Gear change fork pivot worn. 	<ul style="list-style-type: none"> - Change gear fork. - Change. Go to a specialist workshop. - Change. Go to a specialist workshop. - Change. Go to a specialist workshop. - Change shaft. Go to a specialist workshop.
15	Clutch slipping	<ul style="list-style-type: none"> - No play in the clutch handle. - Clutch plate worn. - Clutch housing worn. - Clutch spring broken or weak. - Clutch plates worn. 	<ul style="list-style-type: none"> - Go to a specialist workshop. - Replace the clutch plate. Go to a specialist workshop. - Replace the clutch hub. - Adjust the selector position spring or change it. - Change the clutch disks. Go to a specialist workshop.
16	Bike unstable	<ul style="list-style-type: none"> - Cable obstructs handlebars. - Steering shaft nut too tight. - Steering bearings damaged or worn. - Steering shaft bent. 	<ul style="list-style-type: none"> - Put the cable to one side and release it a little. - Undo the steering shaft nut. - Replace the steering bearing. - Change the steering shaft. Go to a specialist workshop
17	Shock absorption too hard	<ul style="list-style-type: none"> - Front forks excess oil. - Front fork oil viscosity too high. - Front forks twisted. - Excessive tyre pressure. 	<ul style="list-style-type: none"> - Eliminate the excess oil to an adequate level. - Empty the fork oil and fill with oil of the recommended viscosity. - Change front fork. Go to a specialist workshop. - Verify tyre pressure.

	FAULT	CAUSE	SOLUTION
17	Shock absorption too hard	<ul style="list-style-type: none"> - Rear shock badly adjusted 	<ul style="list-style-type: none"> - Adjust the rear shock.
18	Shock absorption too soft	<ul style="list-style-type: none"> - Front forks low oil. - Front fork oil viscosity too low. - Front forks twisted. - Low tyre pressure. - Rear shock absorber maladjusted. 	<ul style="list-style-type: none"> - Add oil to the forks as required. - Empty the fork oil and fill with oil of the recommended viscosity. - Change front fork. Go to a specialist workshop. - Verify tyre pressure. - Adjust the rear shock.
19	The bike makes unusual noise	<ul style="list-style-type: none"> - Drive chain incorrectly adjusted. - Chain worn. - Rear sprocket worn. - Chain lubrication insufficient. - Rear wheel misaligned. - Oil front fork insufficient. - Front fork spring weak or broken. - Brake disk worn. - Brake pads incorrect position or crystallised. - Cylinder damage. - Brackets, nuts, bolts not properly tightened. 	<ul style="list-style-type: none"> - Adjust the chain. - Change the chain, rear sprocket and secondary transmission pinion. - Change the rear sprocket. - Lubricate using a correct chain lubricant. - Align the rear wheel. Go to a specialist workshop. - Add oil to the forks as required. - Replace the front fork spring. - Replace the brake disk. - Refit the pads or change them. - Replace the damaged cylinder. - Verify and adjust to the correct tightening torques.
20	Handlebar shakes or excessively vibrates	<ul style="list-style-type: none"> - Tyre worn, swing arm or needle bearing worn. - Rim off-centre. - Rear wheel misaligned. - Steering shaft play. - Handlebar bracket loose, steering shaft bolt loose. 	<ul style="list-style-type: none"> - Change worn parts. - Centre the rim. - Verify the tension of the wheel spokes. Re-adjust if necessary. - Check the distance between steering shafts and adjust if necessary. - Tighten the handlebar bracket and the steering shaft bolt to the correct tightening torques.

	FAULT	CAUSE	SOLUTION
21	Motorcycle pulls to one side	<ul style="list-style-type: none"> - Chassis twisted. - Steering incorrectly adjusted. - Steering shaft bent. - Front forks twisted. - Rear wheel misaligned. 	<ul style="list-style-type: none"> - Change the chassis. Go to a specialist workshop. - Adjust the steering. Go to a specialist workshop. - Change steering shaft. Go to a specialist workshop. - Change front fork. - Align the wheels.
22	The brakes do not function correctly	<ul style="list-style-type: none"> - Disk worn. - Loss of brake fluid. - Brake fluid deteriorated. - Piston cylinder broken. - Brakes incorrectly adjusted. 	<ul style="list-style-type: none"> - Change disk. - Check the brake circuits. Change those that are damaged or broken. - Drain the brake fluid and put a new product, recommended by the maker. - Replace the piston cylinder. - Adjust the brakes.
23	The lights blow	<ul style="list-style-type: none"> - Voltage regulator faulty. 	<ul style="list-style-type: none"> - -Remove the seat and the fuel tank and check the connectors and the regulator.
24	The lighting system does not work	<ul style="list-style-type: none"> - The light cable connector is destroyed or disconnected 	<ul style="list-style-type: none"> - Remove the back light cover.

WARRANTY TERMS AND CONDITIONS

(According to Law decree 23/2003 on the 10th of July, covering Warranties on Consumer Item Sales)

Warranty terms of the manufacturer GASGAS Motos, S.A.

The company GAS GAS MOTOS, S.A. (hereafter referred to as “GG”), with this present document guarantees the consumer, the purchaser of a vehicle manufactured by GG, that both the materials and the manufacturing are free of defects in accordance with the highest standards of quality. Consequently, GG with this document guarantees the consumer (hereafter referred to as the “purchaser”), in accordance with the conditions set out below, the repair, free of charge, of any defect in materials or that might result from faulty manufacture that is detected in a new motorcycle within the period covered by this Warranty and with no limit on the number of kilometres covered or hours of use.

Warranty Period

The period covered by this Warranty will begin on the day of delivery of the vehicle to the purchaser by a GG authorised dealer, or in the case of demonstration models, on the date in which the vehicle is used for the first time. The seller will be responsible for any unwarranted faults that become apparent within the period established in the Law decree 23/2003 on the 10th of July covering Warranties on Consumer Goods Sold from the time of delivery and in accordance with the Directive 1999/44/EC for other members of the European Community. For countries outside the European Community, the Warranty Period will be determined by the existing regulations in those countries. Nevertheless, should the fault appear during the first six months after the delivery of the motorcycle, it will be presumed that the said fault existed at the time of delivery; from the end of the sixth month onwards, the purchaser must demonstrate that the unwarranted fault existed at the moment of delivery. During the first six months subsequent to the delivery of the repaired vehicle, the seller will be responsible for any unwarranted faults arising out of the repair.

Any defects detected in the product must be brought to the attention of a GG authorised dealer within the Warranty Period. If the last day of this period is a Sunday or an official holiday, the Warranty period will be extended such that the last day of the period covered will be the first working day after the Sunday or official holiday.

Those claims under Warranty for defects not brought to the attention of a GG authorised dealer before the end of the Warranty Period will be excluded.

Obligation of the purchaser

GG will have the right to reject any claims under Warranty in the event that:

- a) The purchaser has failed to submit the vehicle to any of the inspections and/or maintenance work required in the Users' Manual, or has exceeded the date set for such inspections or maintenance work. Also excluded from guarantee are those faults that appeared prior to the dates established for an inspection or maintenance work where the latter was not carried out, or was carried out later than the date established.
- b) An inspection, maintenance or repair has been performed on the vehicle by third parties not recognised or authorised by GG.
- c) Any maintenance or repair has been carried out on the vehicle that violates the technical requirements, specifications and/or instructions indicated by the manufacturer.
- d) Spare parts whose use has not been authorised by GG have been used during the course of maintenance work or repairs to the vehicle, or in the event that the vehicle has been used with fuels, lubricants or other liquids (including, amongst others, cleaning products) that have not been expressly mentioned in the specifications set out in the User's Manual.
- e) The vehicle has been altered or modified in any way or fitted with components other than those expressly authorised by GG as accepted components of the vehicle.
- f) The vehicle has been stored or transported in a way that is not in accordance to the corresponding technical requirements.
- g) The vehicle has been used for special purposes other than ordinary use, such as competition, races or record breaking attempts.
- h) The vehicle has been directly or indirectly damaged as a result of a fall or an accident.

Warranty exclusions

The following items are not covered by this Warranty:

- a) Worn parts, including, without any limitation, spark plugs, batteries, petrol filters, oil filter elements, (secondary) chains, engine output pinions, rear sprockets, air filters, brake discs, brake pads, clutch plates and discs, bulbs, fuses, carbon brushes, footrest rubbers, tyres, inner tubes, cables and other rubber components
- b) Lubricants (for example, oil, grease, etc.) and working fluids (for example, battery liquid, coolant, etc.)
- c) Inspection, adjustments and other maintenance tasks, as well as all kinds of cleaning work
- d) Damage to the paint-work and consequent corrosion due to external causes, such as stones, salt, industrial fumes and other environmental impact, or inadequate cleaning with inappropriate products

- e) Any damages caused as a result of the defects, as well as any expenses incurred either directly or indirectly as a consequence of the defects (for example, communication costs, accommodation expenses, car hire costs, public transport costs, breakdown truck fees, courier costs, etc.), as well as other financial losses (for example, those caused by the loss of the use of the vehicle, loss of income, time lost, etc.)
- f) Any acoustic or aesthetic phenomenon that does not significantly affect the condition or use of the motorcycle (for example, small or hidden imperfections, noise or vibrations that are normal in use, etc.)
- g) Phenomena that are the result of the ageing of the vehicle (for example, discolouring of painted or metallic coated surfaces).

Various

- 1.- GG shall have the prerogative to decide, at its own discretion, whether to repair or replace defective parts. Where parts are replaced, ownership of the parts removed shall pass to GG without any other consideration. The GG authorised dealer, to whom the making good of the defects has been entrusted, is not authorised to make any declarations that are binding on GG.
- 2.- In case of doubt regarding the existence of a defect, or a visual or material inspection is required, GG reserves the right to demand the return of the parts which are the object of a claim under Warranty, or to arrange an inspection of the defect by an expert from GG. Any additional obligations arising out of guarantees on parts replaced free of charge, or any other service rendered free of charge, are excluded from the effects of this present warranty. The Warranty on parts replaced within the Warranty Period will end at the expiry date for the Warranty Period of the product concerned.
- 3.- Should it prove to be the case that a defect can not be repaired, the purchaser guaranteed shall have the right to the cancellation of the contract (payment of compensation) or a partial refund of the purchase price (discount), instead of repairing the motorcycle.
- 4.- Any claims against Warranty by the purchaser under the terms of the sale contract with the corresponding authorised dealer shall not be affected by the terms of this present Warranty. Neither will this present Warranty affect those additional contractual rights acquired by the purchaser under the general commercial terms and conditions of the authorised dealer. However, such additional rights may only be exercised through claims against the authorised dealer.
- 5.- Should the purchaser resell the product within the Warranty Period, the duration and conditions of the present Warranty will remain unaltered, in such a way as that the rights to make claims under the present Warranty in accordance with the terms and conditions set out in this present document shall be transferred to the new owner of the motorcycle.